

# Pillar Drills

## User manual



**AW285PD**



**AW315PD**



**AW220RD**



**AW680RD**



# INDEX OF CONTENTS

EU Declaration of Conformity	03
What's Included	04-05-06
General Safety Instructions for 230V Machines	07
General Safety Instructions for Drilling Machines	07
Specification	08
Assembly	09-10-11-12-13
Illustration and Parts Description	14-15-16-17
Changing the Speed	18
Removing Keyless Chuck	19
Maintenance	20
Speed Select Tables	21
Drill Speed Material Table	22
Troubleshooting	23
Exploded Diagrams/Lists	24-25-26-27-28-29-31
Wiring Diagram	32
Notes	33-34-35

## EU DECLARATION OF CONFORMITY

<p><b>Cert No: Drill Press</b></p> <p>Axminster Tool Centre Ltd Axminster Devon EX13 5PH UK <b>axminstertools.com</b></p> <p>declares that the machinery described:-</p> <table border="1"> <tr> <td>Type</td> <td><b>Pillar Dills</b></td> </tr> <tr> <td>Model</td> <td><b>AW285PD, AW315PD, AW220RD, AW680RD</b></td> </tr> </table> <p>Signed </p> <p><b>Andrew Parkhouse</b> Operations Director</p> <p>Date: <b>09/01/2018</b></p>	Type	<b>Pillar Dills</b>	Model	<b>AW285PD, AW315PD, AW220RD, AW680RD</b>	<p><b>EU Declaration of Conformity</b></p> <p><b>This machine complies with the following directives:</b></p> <table border="0"> <tr> <td>2006/42/EC</td> <td>EN 61000-3-2:2014</td> </tr> <tr> <td>2006/95/EC</td> <td>EN 61000-3-3:2013</td> </tr> <tr> <td>EN 55014-1:2017</td> <td>EN 55014-1:2006+A1+A2</td> </tr> <tr> <td>EN 55014-2:2015</td> <td>EN 55014-2:1997+A1+A2</td> </tr> </table> <p>conforms to the machinery example for which the EC Type-Examination Certificate No AE 50397160, AE 50397197 has been issued by <b>Laizhou Planet Machinery Co., Ltd.</b> at: Yutai West Street Laizhou 261400 Shandong China (Mainland)</p> <p>and complies with the relevant essential health and safety requirements.</p>	2006/42/EC	EN 61000-3-2:2014	2006/95/EC	EN 61000-3-3:2013	EN 55014-1:2017	EN 55014-1:2006+A1+A2	EN 55014-2:2015	EN 55014-2:1997+A1+A2
Type	<b>Pillar Dills</b>												
Model	<b>AW285PD, AW315PD, AW220RD, AW680RD</b>												
2006/42/EC	EN 61000-3-2:2014												
2006/95/EC	EN 61000-3-3:2013												
EN 55014-1:2017	EN 55014-1:2006+A1+A2												
EN 55014-2:2015	EN 55014-2:1997+A1+A2												

The symbols below advise the correct safety procedures when using this machine.

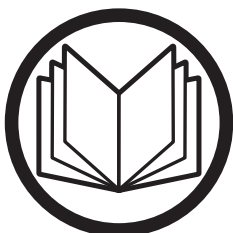

Fully read manual  
and safety instructions  
before use

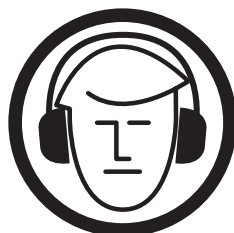

Ear protection  
should be worn



Eye protection  
should be worn



Dust mask  
should be worn



HAZARD

## WHAT'S INCLUDED

**Model Number** AW285PD (ZQJ4113A)

Quantity	Item	Part
1	Small Bench Pillar Drill	A

**Model Number** AW220RD (ZQJ3116)

Quantity	Item	Part
1	Bench Radial Drill	C

**Model Number** AW315PD (ZQJ4116Q)

Quantity	Item	Part
1	Medium Bench Pillar Drill	B

**Model Number** AW680RD (ZQJ3116A)

Quantity	Item	Part
1	Floor Radial Drill	D

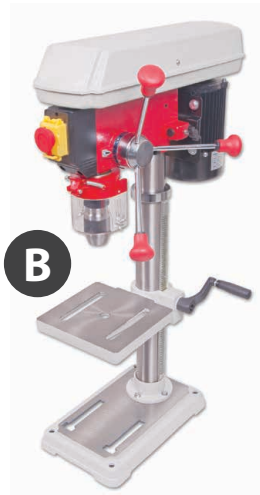

### Box Containing:

1	Pillar for drill head complete with mounting flange, rise and fall rack and retaining ring	1	
1	Drill table with mounting flange	2	(107691 ONLY)
		2a	(107690 ONLY)
1	Drill table extension bracket arm	2b	(107693 ONLY)
		2c	(107692 ONLY)
1	Extension bracket arm	2d	(107692 and 107693 ONLY)
1	Drill table square	2e	(107692 ONLY)
	Drill table round	2f	(107693 ONLY)
1	Base	3	
1	Pillar drill head	4	
1	Radial drill head with spacer block	4a	(107692 and 107693 ONLY)
1	Drill guard assembly	5	
3	Lever feed handles	6	
1	Keyless chuck	7	
1	Morse taper arbor for chuck assembly	8	
1	Crank handle for table rise and fall mechanism	9	
	Lift and shift handle clamps for the rise and fall mechanism, drill table and radial drill head column clamps	10	
1	Morse taper drift	11	
4	M8 x 20mm + washers	12	(107691 and 107692 ONLY)
4	M8 x 35mm + washers	12	(107693 ONLY)
3	M8 x 20mm + washers	12	(107690 ONLY)
2	Hex Keys 3-4mm	13	
2	Table clamping threaded bolts washers and wing nuts	14	(107693 ONLY)

## WHAT'S INCLUDED

---

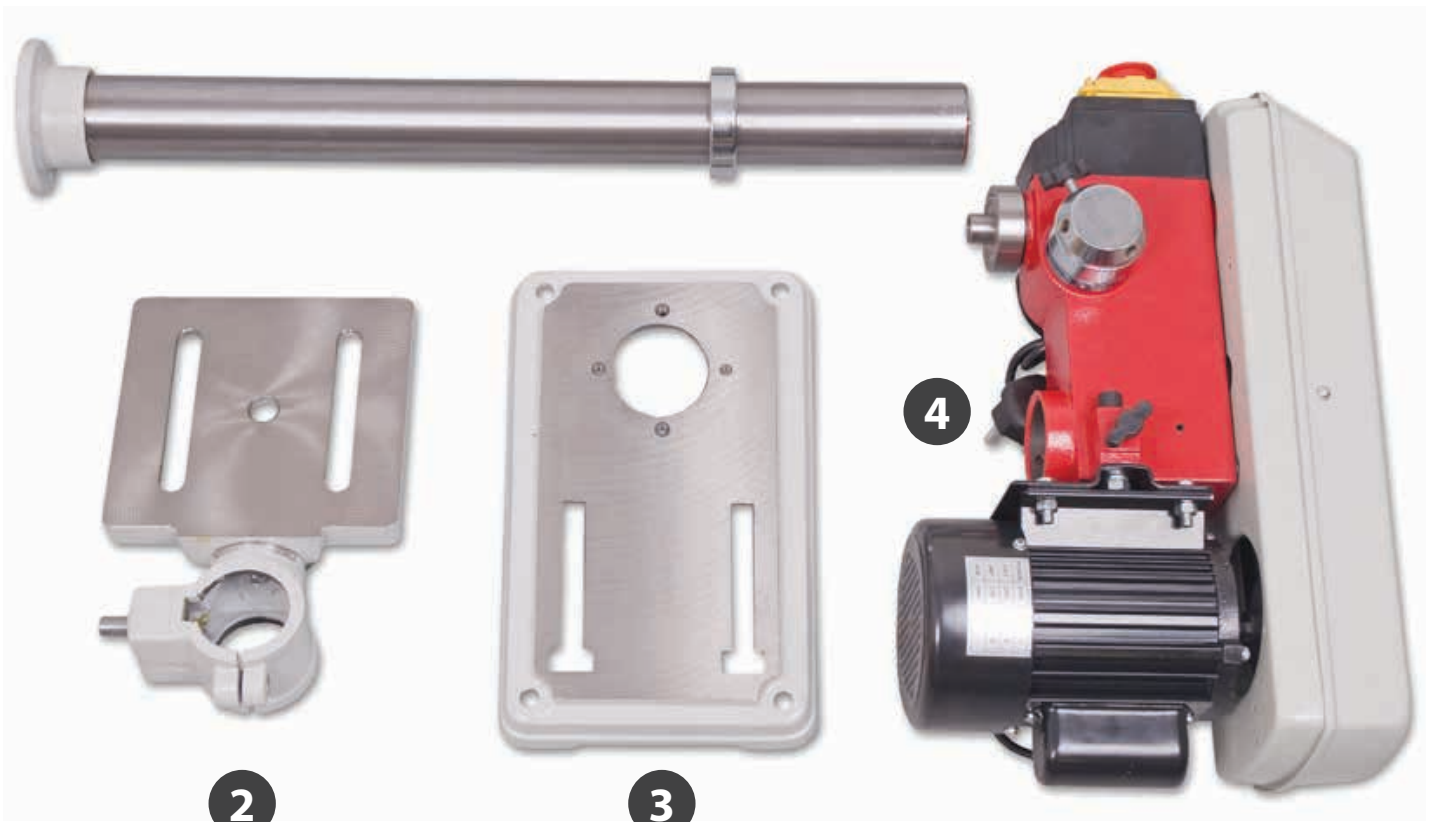



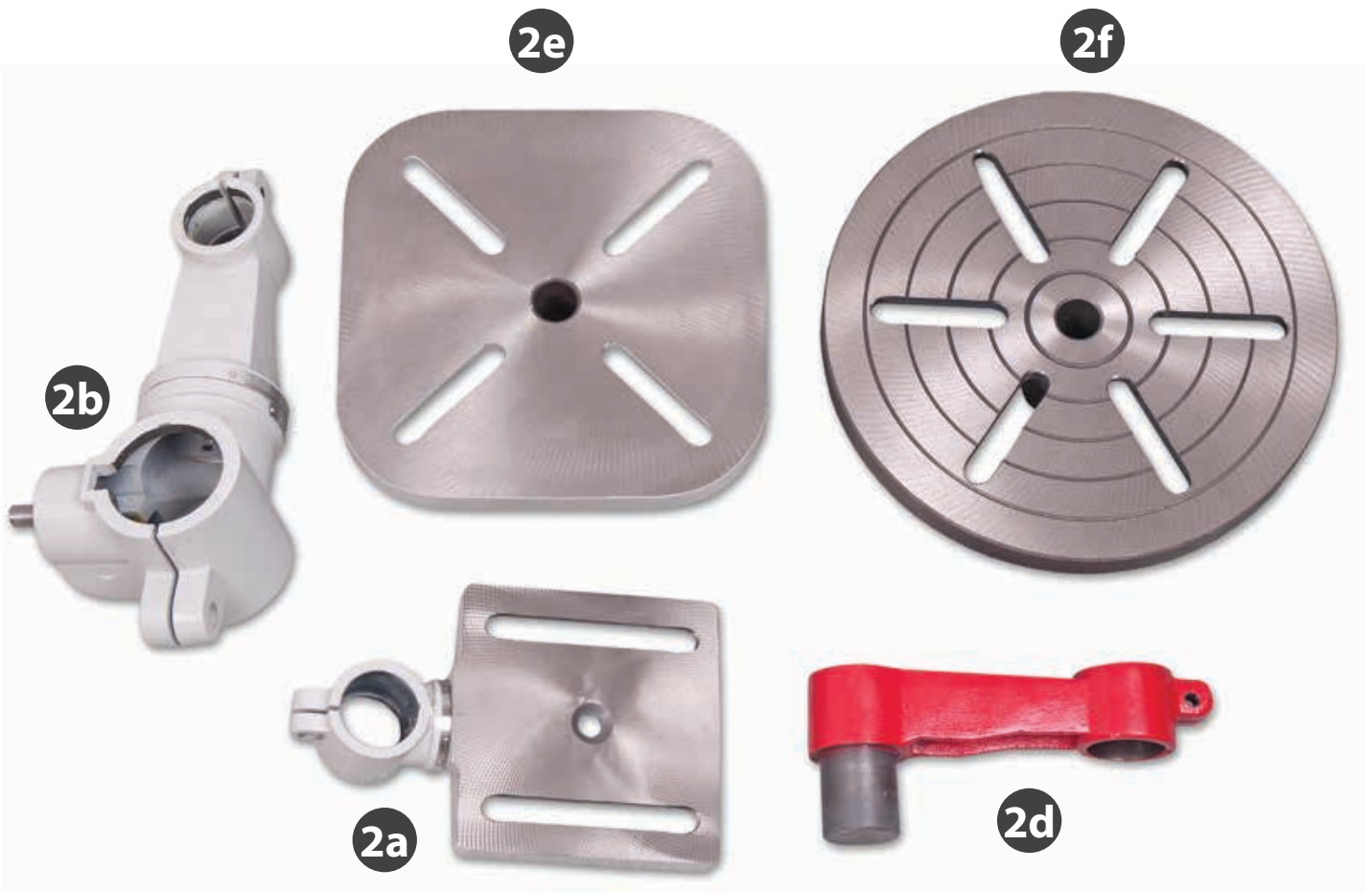
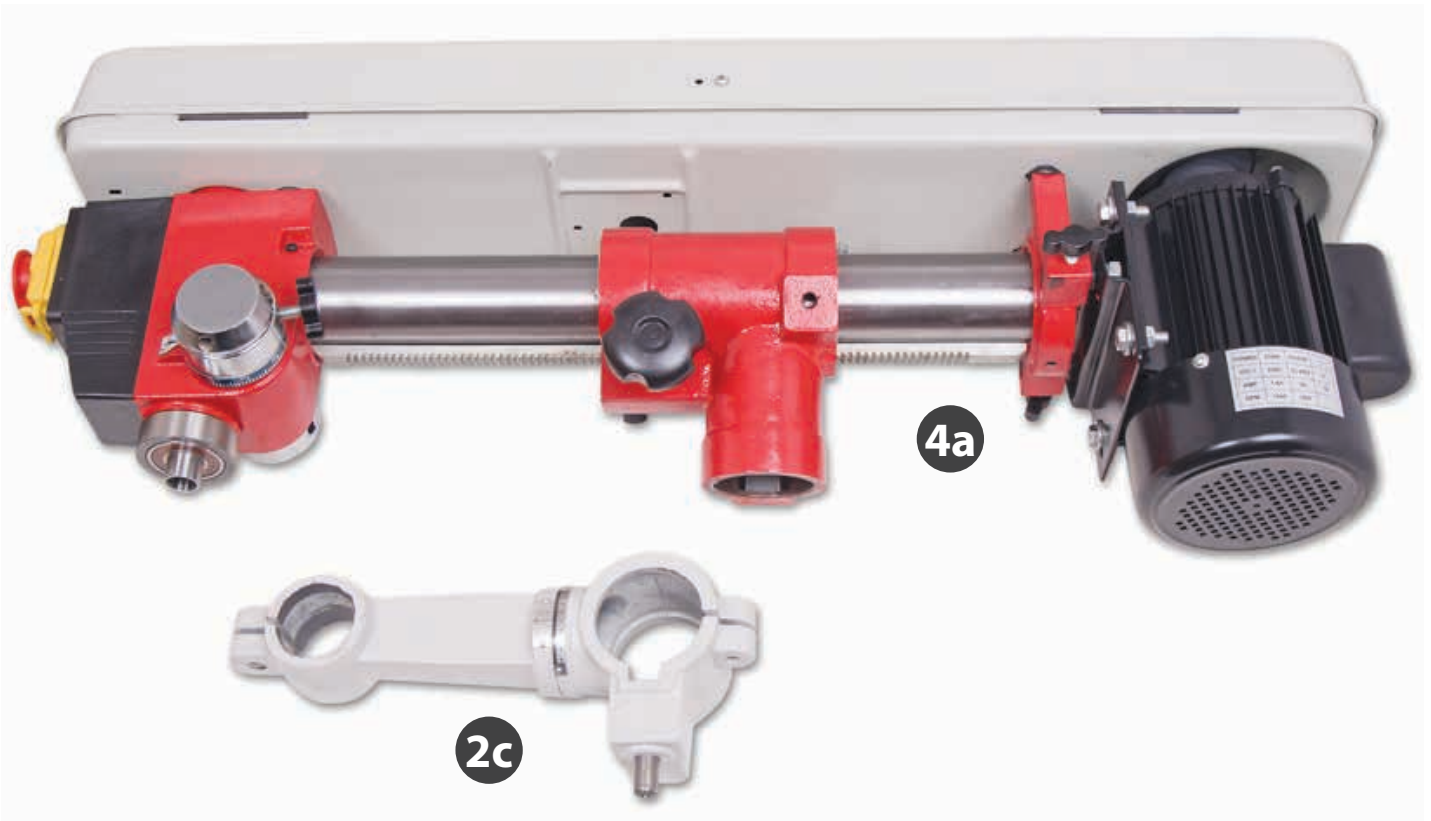

# WHAT'S INCLUDED



## GENERAL SAFETY INSTRUCTIONS FOR 230V MACHINES

The following will enable you to observe good working practices, keep yourself and fellow workers safe and maintain your tools and equipment in good working order.



**WARNING!! KEEP TOOLS AND EQUIPMENT OUT OF REACH OF YOUNG CHILDREN**



**KEEP WORK AREA AS UNCLUTTERED AS IS PRACTICAL. UNDER NO CIRCUMSTANCES SHOULD CHILDREN BE ALLOWED IN WORK AREAS.**

### Mains Powered Tools

- Tools are supplied with an attached 13 Amp UK 3 pin plug, fitted with 13 amp fuse.
- Inspect the cable and plug to ensure that neither are damaged. Repair if necessary by a suitably qualified person.
- Do not use when or where it is liable to get wet.

### Workplace

- Do not use 230V a.c. powered tools anywhere within a site area that is flooded.
- Keep machine clean.
- Leave machine unplugged until work is about to commence.
- Always disconnect by pulling on the plug body and not the cable.

- Carry out a final check e.g. check the cutting tool is securely tightened in the machine and the correct speed and function set.
- Ensure you are comfortable before you start work, balanced, not reaching etc.
- Wear appropriate safety clothing, goggles, gloves, masks etc. Wear ear defenders at all times.
- If you have long hair wear a hair net or helmet to prevent it being caught up in the rotating parts of the machine.
- Consideration should be given to the removal of rings and wristwatches.
- Consideration should also be given to non-slip footwear etc.
- If another person is to use the machine, ensure they are suitably qualified to use it.
- Do not use the machine if you are tired or distracted
- Do not use this machine within the designated safety areas of flammable liquid stores or in areas where there may be volatile gases.
- Check cutters are correct type and size, are undamaged and are kept clean and sharp, this will maintain their operating performance and lessen the loading on the machine.
- **OBSERVE....** make sure you know what is happening around you and **USE YOUR COMMON SENSE.**

## GENERAL SAFETY INSTRUCTIONS FOR DRILLING MACHINES

**1. DO NOT** operate the machine without a preliminary inspection.

**2. CHECK** that the speed is correct for the operation, and upper drive belt cover is closed and fastened.

**3. CHECK** the drill bit is the correct size and type, is correctly fitted and tightened in the chuck.

**4.** Make sure that the drillhead, the table bracket arm, the table tilt and the table swivel clamps are all locked before any drilling.

**5. DO NOT** attempt to carry out any drilling operation on material that has not been secured to the drill table, either by vice or clamp.

**6.** Remove any tools (chuck key, spanners etc), that may have been used in setting up operations and put them away.

**7.** Arrange the drilling operation so that the drill tip does not come in contact with the table.

**8. ALWAYS** allow the drill to stop before removing drills or swarf from around the job or the table.

**9. NEVER** remove 'flying' swarf strands from the drill whilst it is turning.

**10.** It is a good precaution to wear eye protection when drilling, especially using small drills, or very hard material.

**11.** Avoid wearing gloves when operating a drill press.

**12.** After the job is completed, remove all tool accessories, check that drill bits are still sharp and re-use able.

**13.** Clean the machine thoroughly, including removing coolant cutting compound.

**14.** Lightly coat all metal surfaces with a light oil.

**15.** Disconnect the machine from the supply. Secure the cable/ plug clear of the floor.

## SPECIFICATION

<b>Code</b>	<b>107690</b>
Model	AW285PD
Rating	Workshop
Power	350W 50Hz (230V 1ph)
Speed Range	(5) 600 - 2,500 rpm
Swing	210 mm
Chuck Size	1-13 mm Keyless
Chuck Travel	50 mm
Diameter of Column	46 mm
Max Chuck to Table	285 mm
Max Chuck to Base	380 mm
Table Tilt	-45° to +45°
Base Size	285 x 185 mm
Collar Diameter	40 mm
Quill Diameter	45 mm
Table Size	165 x 165 mm
Overall L x W x H	500 x 280 x 735 mm
Weight	26 kg

<b>Code</b>	<b>107692</b>
Model	AW220RD
Rating	Workshop
Power	550W 50Hz (230V 1ph)
Speed Range	(5) 500-2,450 rpm
Swing	840 mm
Chuck Cap/Type	3-16 mm Keyless
Throat	420 mm
Taper	2 MT
Chuck Travel	80 mm
Horizontal Arm Travel	320 mm
Diameter of Column	60 mm
Max Chuck to Table	220 mm
Max Chuck to Base	375 mm
Table Tilt	-45° to +45°
Base Size	215 x 340 mm
Quill Diameter	40 mm
Table Size	230 x 210 mm
Overall L x W x H	840 x 320 x 790 mm
Weight	37 kg

<b>Code</b>	<b>107691</b>
Model	AW315PD
Rating	Workshop
Power	550W 50Hz (230V 1ph)
Speed Range	(12) 210-2,580rpm
Swing	254mm
Chuck Cap/Type	1-16 mm Keyless
Throat	127 mm
Taper	2 MT
Chuck Travel	60 mm
Diameter of Column	60 mm
Collar Diameter	60 mm
Max Chuck to Table	315 mm
Max Chuck to Base	430 mm
Table Tilt	-45° to +45°
Base Size	340 x 210 mm
Quill Diameter	40 mm
Table Size	240 x 240 mm
Overall L x W x H	530 x 280 x 840 mm
Weight	37 kg

<b>Code</b>	<b>107693</b>
Model	AW680RD
Rating	Workshop
Power	550W 50Hz (230V 1ph)
Speed Range	(5) 500-2,450 rpm
Swing	840 mm
ChuckCap/Type	3-16 mm Keyless
Throat	420 mm
Taper	2 MT
Chuck Travel	80 mm
Horizontal Arm Travel	320 mm
Diameter of Column	70 mm
Max Chuck to Table	680 mm
Max Chuck to Base	1,180 mm
Table Tilt	-45° to +45°
Base Size	450 x 270 mm
Quill Diameter	40 mm
Table Size	310 mm diameter
Overall L x W x H	820 x 320 x 1,630 mm
Weight	61 kg



Having unpacked your machine and accessories, check the contents against the equipment list "What's Included"; if there are any discrepancies, please contact Axminster Tool Centre using the guide on our website.



**PLEASE DISPOSE OF THE PACKAGING RESPONSIBLY; MUCH OF THE MATERIAL IS RECYCLABLE**

The machine and its accessories arrive coated with heavy corrosion preventative grease and wax paper or plastic wrapping. These will need to be cleaned from the machine, its components and accessories prior to it being set up and commissioned. Use water soluble degreaser to remove. Be warned, it will stain if you splash clothing etc. After cleaning, lightly coat exposed metal.



**WARNING! WEAR OVERALLS AND EYE PROTECTION!**

surfaces of the machine with a thin layer of light machine oil. N.B If you used water soluble de greaser make sure you apply this thin film swiftly.

**Please read the Instruction Manual prior to using your new machine; as well as the installation procedure, there are daily and periodic maintenance recommendations to help you keep your machine in good condition and prolong life. Keep this instruction manual accessible for others who may also be required to use the machine.**

**Please read through the section entitled Illustration and parts description, to identify the parts easily.**



**WARNING! THE DRILL HEAD IS A HEAVY PIECE OF MACHINERY, YOU ARE ADVISED TO HAVE HELP TO LIFT IT CLEAR OF THE BOX AND TO FIT.**

1. Place the base (3) on the bench or floor and place the mounting flange of the column (1) onto the seating flange of the base, align the holes. Use the four Hex bolts and secure the column to the base, see fig 1. Loosen the grub screw holding the chamfered retaining collar on the column with the supplied Hex key, place it and the rise and fall rack assembly aside, see fig 2.

**Fig 01**

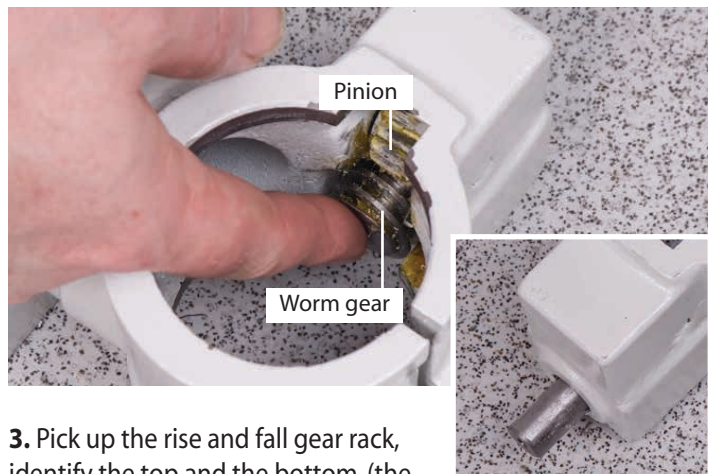

**Fig 02**



2. Take the drill table mounting bracket arm (2,2a,2b,2c) and twist the worm drive shaft with your fingers so that the whole shaft protrudes from the casting and the worm gear itself is clear of the square recess in the main body of the casting (see fig 3).

**Fig 03-04**



3. Pick up the rise and fall gear rack, identify the top and the bottom, (the rack gearing is cut asymmetrically, with the gear cut extending closer to the bottom), make sure you have the rack the right way up, as it will allow you to drive the drill table up and down over its full range, see fig 5.

**Worm gear shaft**

**Fig 05**



4. Fit the rise and fall rack into the square recess in the mounting body casting, ensure that it is engaged with the pinion, see figs 6 and lower the combined mechanism over the column (1). Allow it to slide down the column until the rise and fall rack is located in the cup chamfer in the top of the mounting flange, see figs 7. Replace the cup chamfered retaining



## ASSEMBLY

collar over the column and slide it down onto the top of the rack. Lock it in place with the grub screw, ensuring that it has captured the upper end of the rack securely, but not too tight that the rack cannot be swivelled around the pillar see fig 8.

**Fig 06-07**

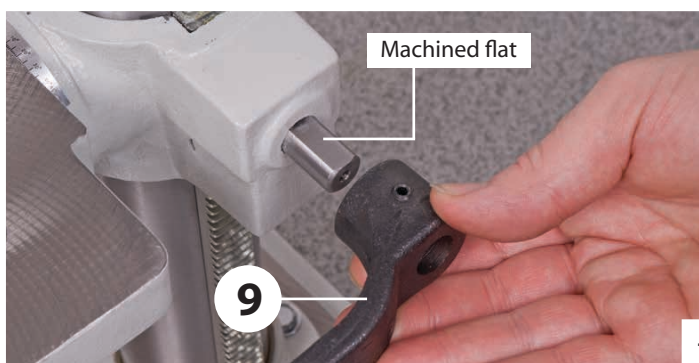

**Fig 08**



5. Locate and fit the crank handle (9) to the shaft, ensuring that you tighten the grub screw onto the machined flat on the shaft, this will keep the worm gear in position, see figs 9-10.

**Fig 09**



6. Check that the bracket can be driven up and down the column and can swivel around the pillar. Locate the lift and shift clamping handle (10) and screw it into the threaded hole to the rear of the mounting bracket arm (2) and tighten, see fig 11. Check it has 'pinched' up on the column and the bracket is immobile; both in its up and down travel and swivel movement.

**Fig 11**

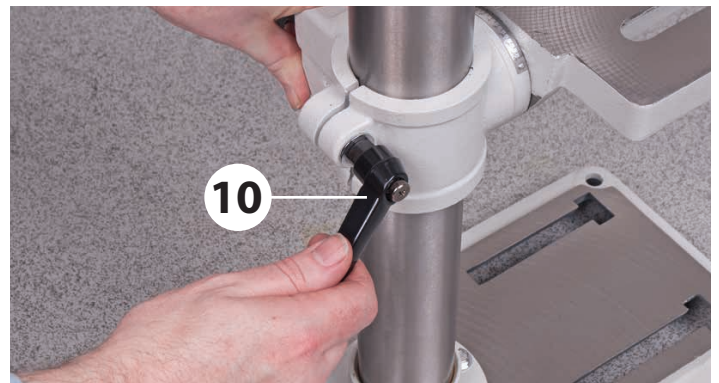

### Radial Standing Drill Only

7. Slot the drill table (2e or 2f) into the machined hole to the front of the mounting arm (2b and 2c) and screw a lift and shift clamping handle (10) into to the threaded hole beneath the table and tighten, see figs 12-13. Check it has 'pinched' up on the drill table spigot and the drill table is immobile.

**Fig 12-13-14**

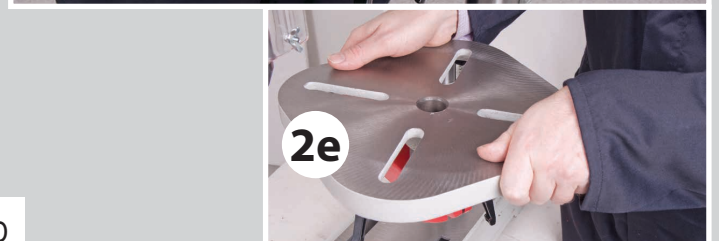
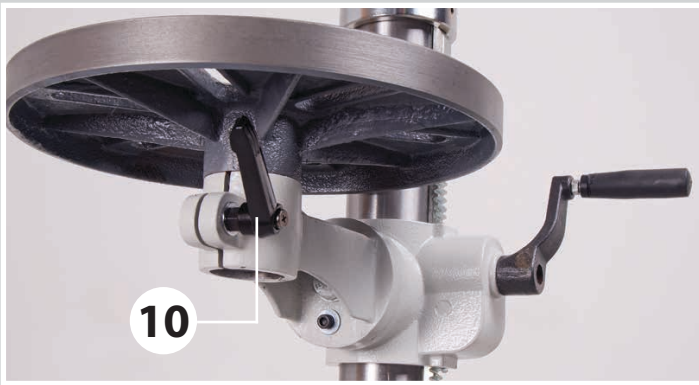



Fig 17-18-19



**Note:** On the two radial drills fit the extension arm (2d) into the mounting arm (2b and 2c) then the tables, see figs 14-15-16.

Fig 15-16



**Radial Pillar Drill Head Only**

2. Lay the drill head on its side, locate the column spacer block and insert it into machined recess inside the base of the drill head, see fig 20. Lift the drill head onto the column as described above and secure using a lift and shift handle (10), see figs 21.

Fig 20

**Mounting the Drill Head**

1. Ensure that the two hex socket grub screws that lock the head in place on the column are withdrawn and will not foul the column (1) when the head is fitted, see fig 17. Put the lower assembly (you have just been working on) in the designated position, make sure it is stable and lift the drillhead (4) over the column (1) and let it drop into place, see fig 18. Set the drill head approximately fore and aft and lock in position using the two cap head grub screws mentioned earlier, see fig 19. Check that the drillhead is immobile. Everything on the drilling machine is now secured.

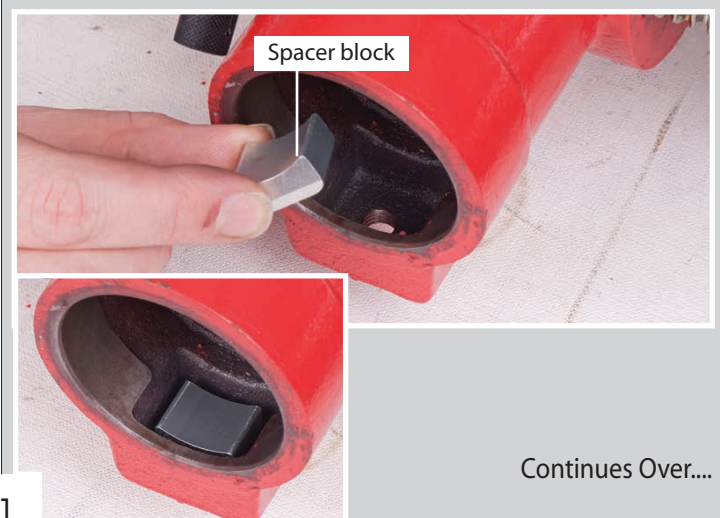

Continues Over...



**NOTE:** Make sure the spacer block does not come out when lifting the drill head onto the column!

**Fig 21**



3. Locate another lift and shift handle (10) and screw it into the threaded hole for the Horizontal clamp assembly, see fig 22.

**Fig 22**



4. Open the pulley cover and check to see if the belt has been tensioned. If not, loosen the two motor yoke locks and push the motor back to tension the belt, see fig 23-24-25. For the floor standing pillar drill head, move the tensioning lever back then re-tighten the motor yoke locks to lock the motor in place, see fig 25-26.

**Fig 23-24**

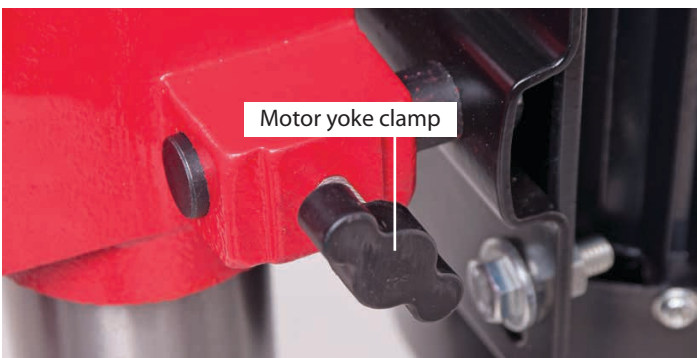

**Fig 25-26**

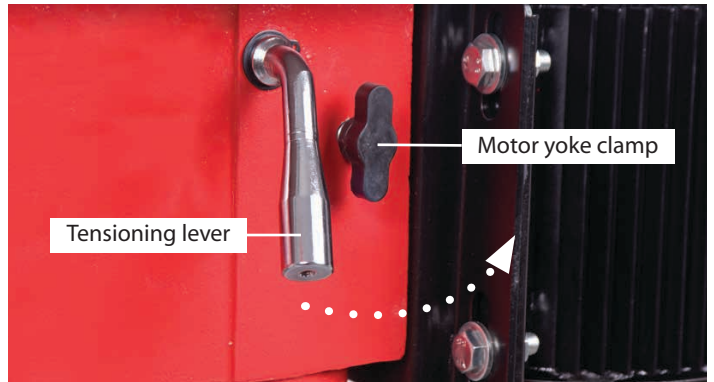

**1-13mm Keyless Chuck AW285PD Only**

Locate the chuck (7) and insert up over the morse taper arbor, using a high faced mallet, lightly tap home.

**3-16mm Keyless Chuck**

Locate the morse taper arbor (8), insert the arbor into the keyless chuck (7) then slot the assembly up into the quill. Using a high faced mallet, lightly tap home, see fig 27-28.

**Fig 27-28**



**Drill Guard**

Locate the drill guard assembly (5), loosen the Phillips screw and nut to the rear of the guard, see fig 29 insert the assembly up over the lower bearing flange of the quill until the assembly is up against the drill casting, re-tighten the screw and nut to lock the guard assembly in place, see fig 30.

**Fig 29-30**



**Lever Feed Handles**

Locate the three lever feed handles (6) and screw them into the threaded holes on the depth stop ring, see fig 31-32.

**Fig 31-32**

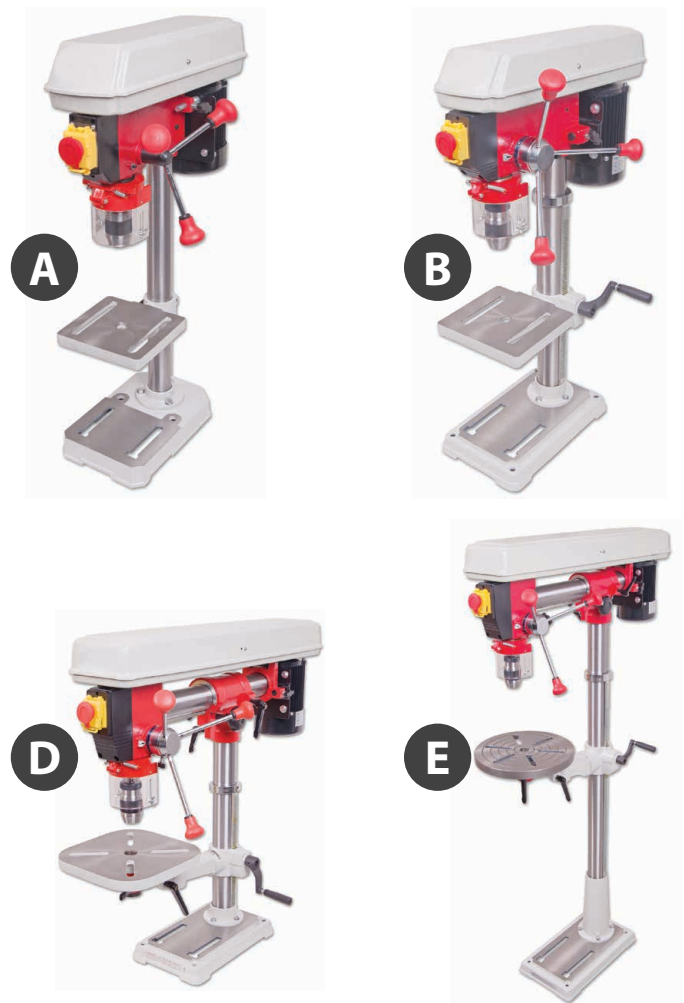

Model	Letter
AW285PD	A
AW315PD	B
AW220RD	C
AW680RD	D



# ILLUSTRATION AND PARTS DESCRIPTION

Belt cover securing screw

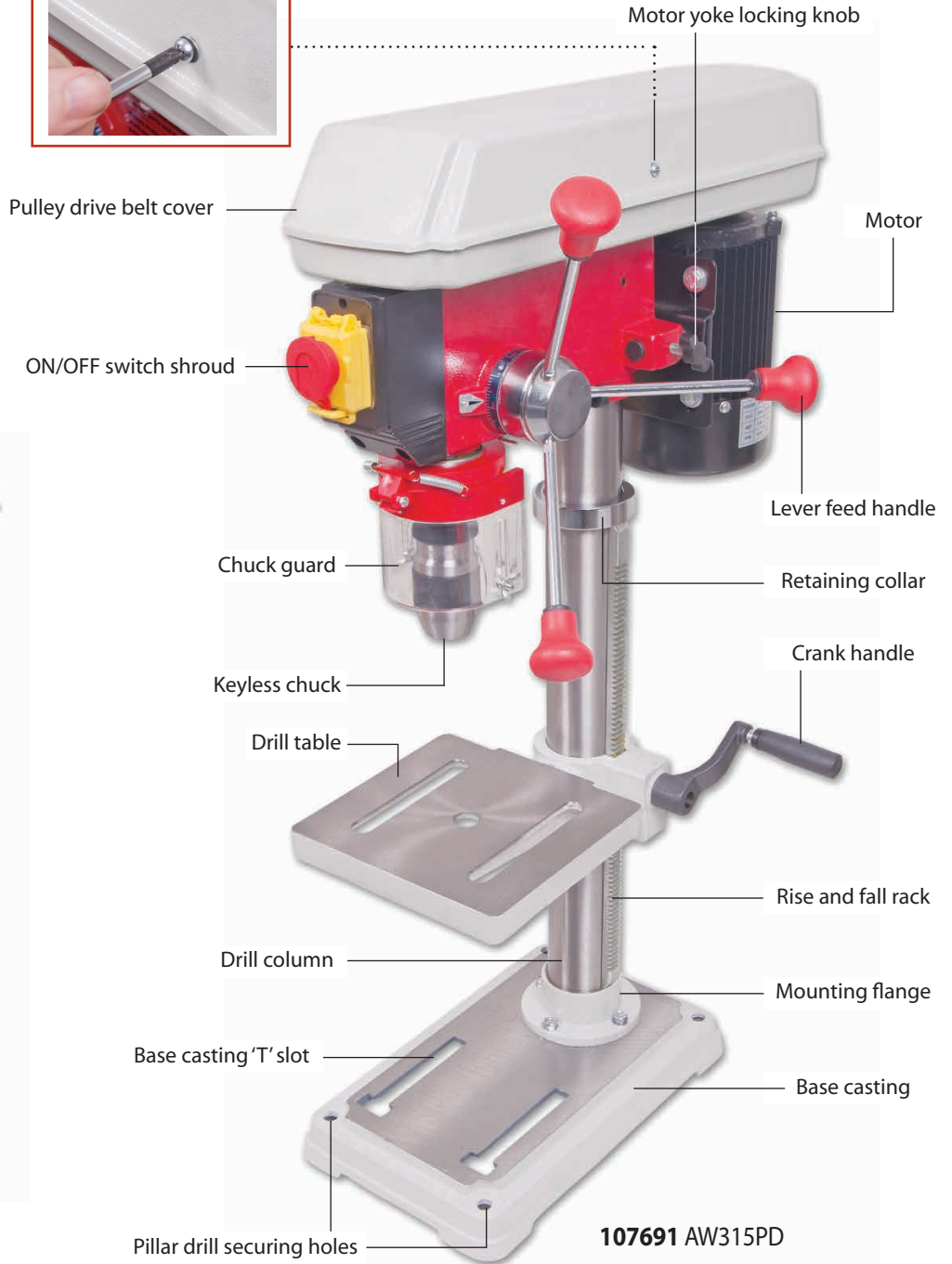
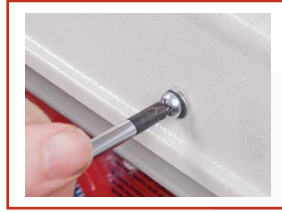

**107690 AW285PD**

Micro switch

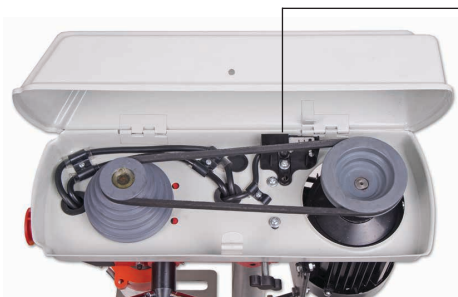

**107690 Drive Pulley**

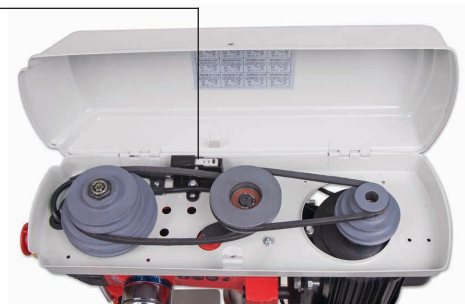

**107691 Drive Pulley**



# ILLUSTRATION AND PARTS DESCRIPTION

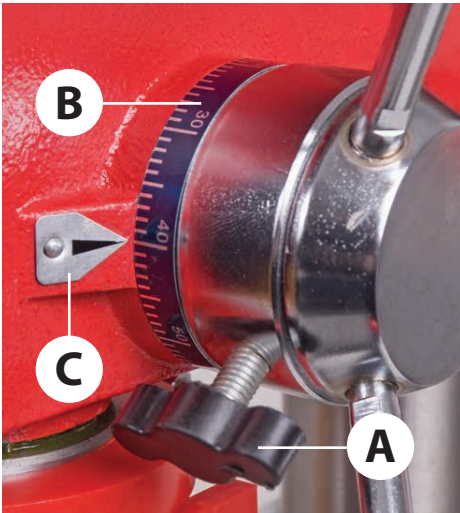

Depth stop clamp (A)  
Depth scale (B), Depth scale pointer (C)

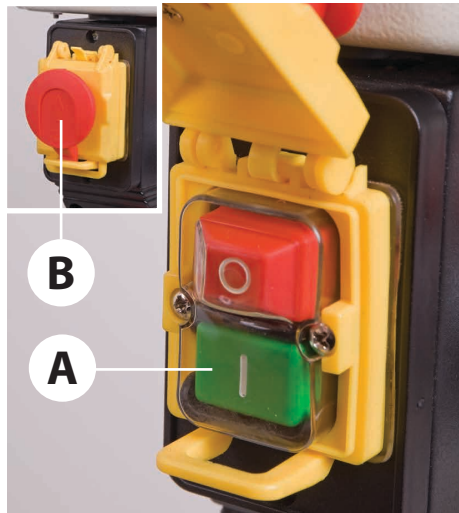

ON/OFF switch (A)  
Emergency stop button (B)

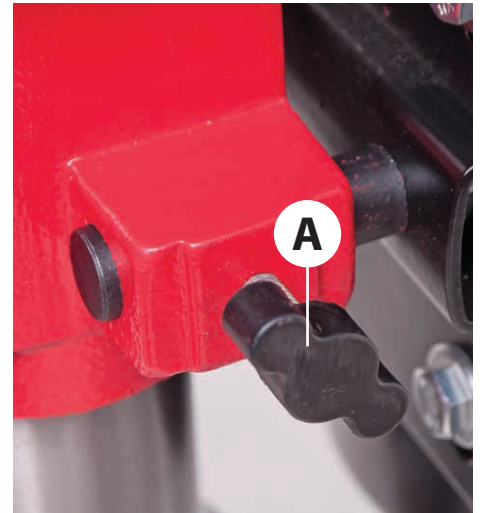

Motor yoke clamp (A)



Table tilt locking bolt



90° Locking bolt

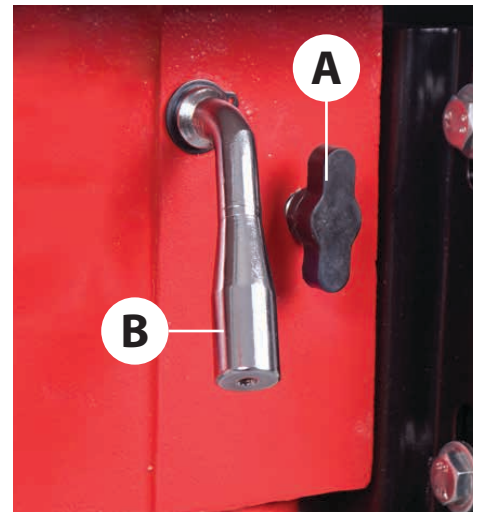

Motor yoke clamp (A)  
Drive belt tensioning lever (B)

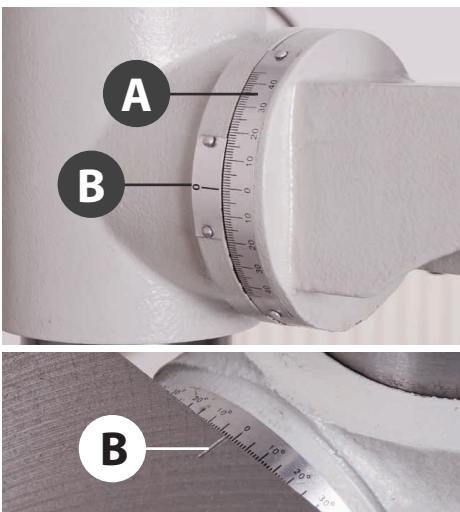
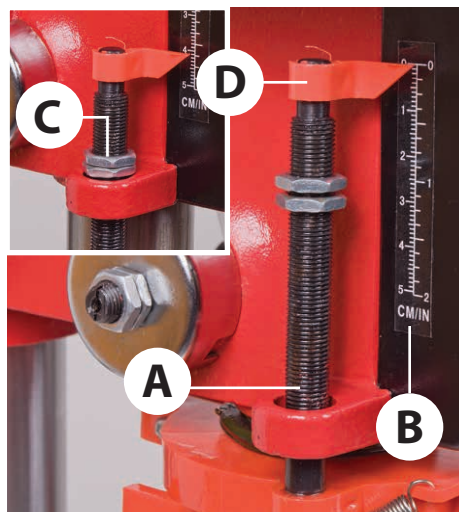
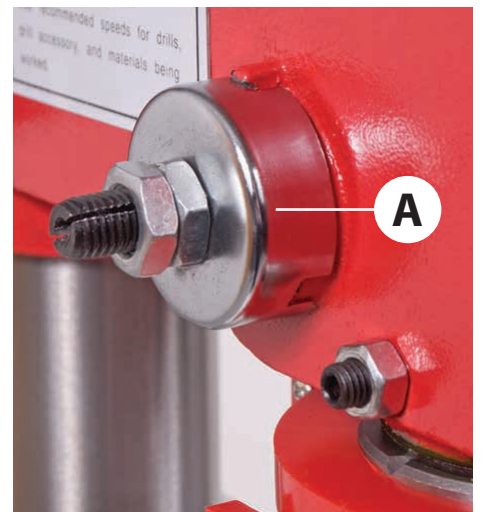

Table tilt scale (A)  
Table tilt pointer (B)



Depth stop assembly (A)  
Depth stop scale (B), Depth stop nuts (C)  
Pointer (D)



Quill rise and full return spring (A)

# ILLUSTRATION AND PARTS DESCRIPTION



**107693 AW680RD**

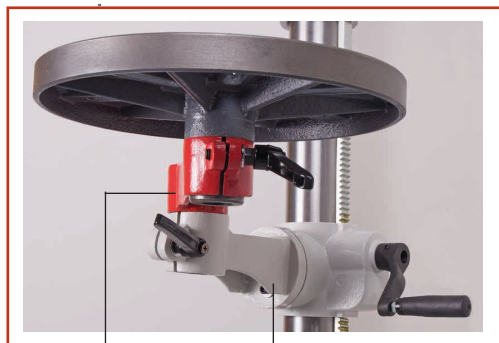

Extension arm      Extension bracket arm

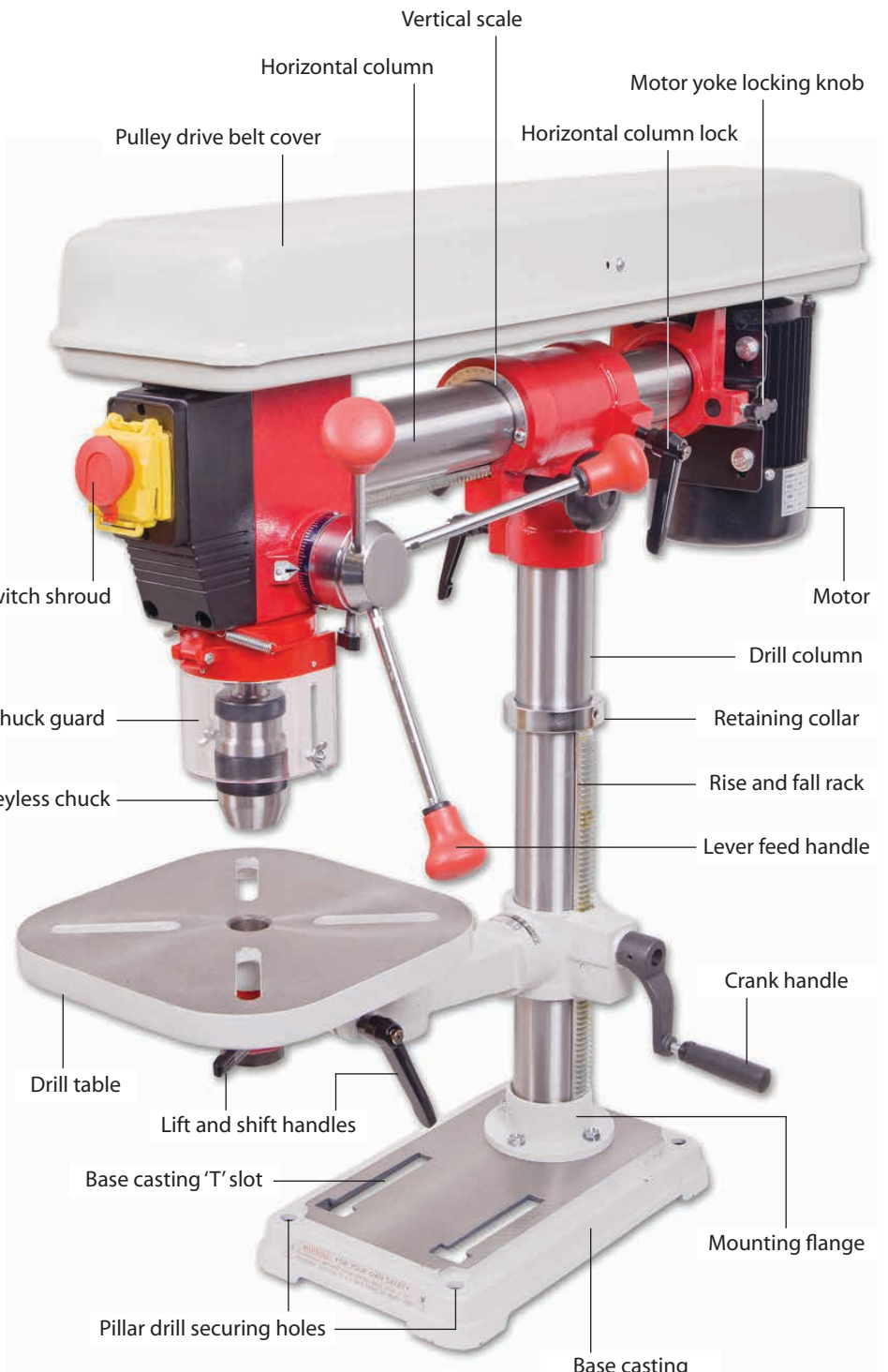

**107692 AW220RD**

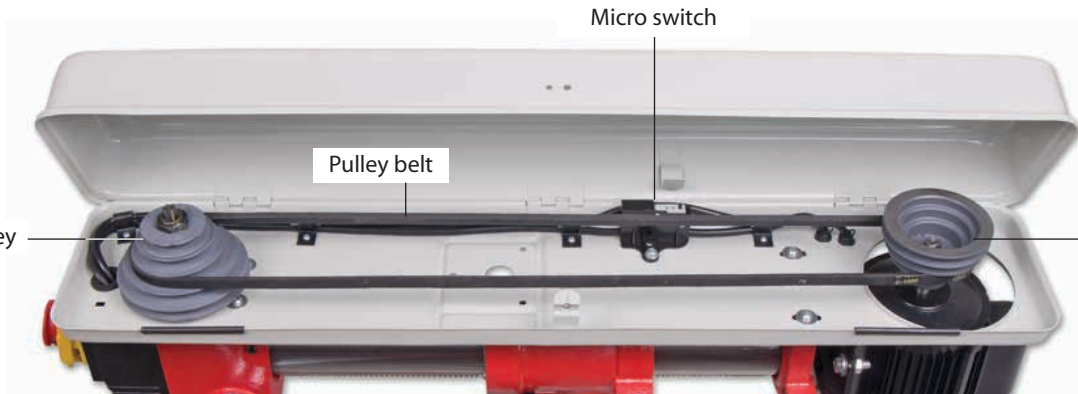



# ILLUSTRATION AND PARTS DESCRIPTION

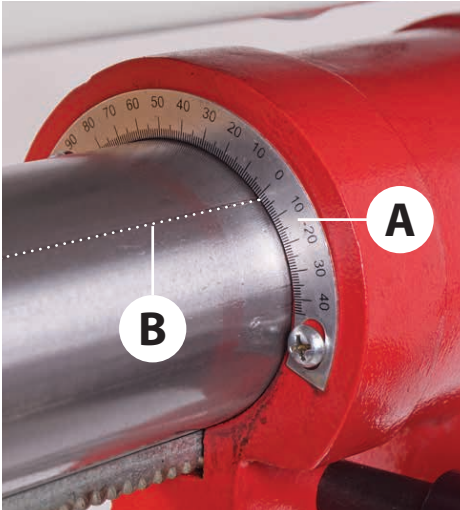

Vertical scale (A)  
Column pointer (B)

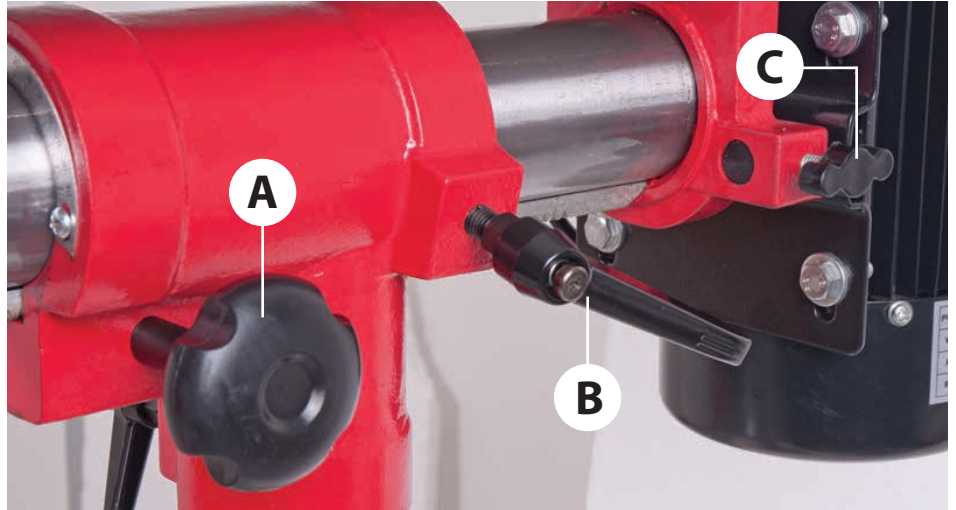

Horizontal column adjusting knob (A)  
Horizontal column clamping handle (B), Motor yoke clamp (C)



Turn the horizontal adjusting knob anti-clockwise to move the column forward



Turn the horizontal adjusting knob clockwise to move the column back



Vertical locking pin



Loosen the horizontal column clamping handle (B). Pull out the vertical locking pin to un-lock the drill head column. Rotate + or - to the appropriate angle using the tilt pointer on the column then retighten the horizontal clamping handle to lock the head in position.

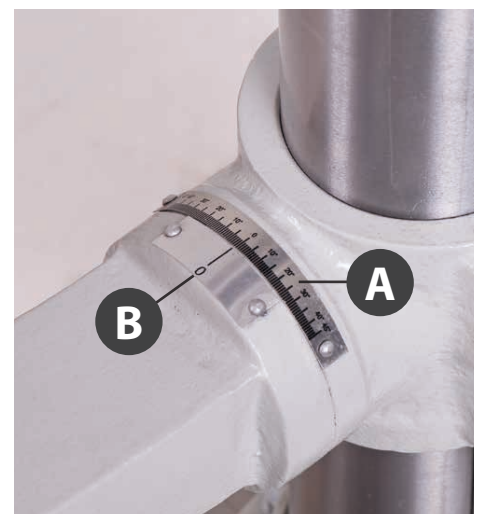

Table tilt scale (A)  
Table tilt pointer (B)

# CHANGING THE SPEED



**WARNING! DISCONNECT THE PILLAR DRILL FROM THE MAINS SUPPLY BEFORE CONTINUING!**

To release the tension, loosen the two motor yoke locks on either side of drill head, push the motor assembly up against the drill head casting, thus releasing the tension on the pulleys, see figs 33-34.

Refer to the (speed select table on page 21) and ascertain the belt positions for speed required.

**Fig 33-34**



AW285PD Drive Pulley



AW315PD Drive Pulley



**WARNING! TAKE CARE NOT TO TRAP YOUR FINGERS WHEN REPOSITIONING THE BELT ON THE PULLEYS!**

## Radial Drills

To release the tension, loosen the motor yoke tensioning locks, push the motor up against the drillhead casting, thus releasing the tension on the pulleys, see fig 35-36.

**Fig 35-36**

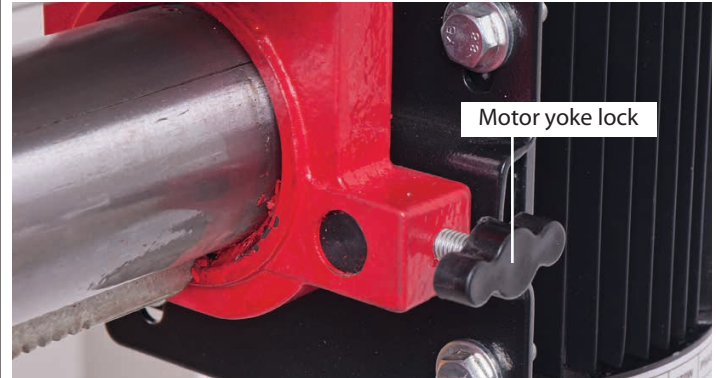

**WARNING! TAKE CARE NOT TO TRAP YOUR FINGERS WHEN REPOSITIONING THE BELT ON THE PULLEYS!**

Turn the pulleys to check the belts move freely. Tension the pulleys by pushing the motor assembly out and securing the motor yoke butterfly knob to lock the motor assembly in position. Lower the belt and pulley cover carefully, (remember the micro switch).



**RE-CONNECT THE SUPPLY AND SWITCH ON. CHECK THE DRILL RUNS SMOOTHLY, NO HARD VIBRATION.**

If all seems satisfactory, recommence drilling operations.



**1.** Lower the quill to its maximum depth by turning the lever feed handle. While holding the handle turn the depth scale ring (A) fully round and then tighten the butterfly depth stop clamp (B) to lock the quill in position, see fig 37.

**Fig 37**

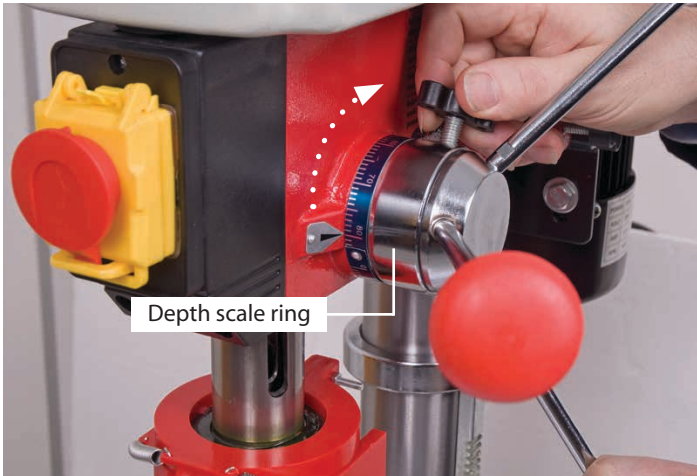

**2.** Place a piece of timber on the drill table to prevent the chuck from being damaged.

**3.** While holding the handle in place turn the chuck to line up the morse taper arbor in the quill's machined slot, see fig 38. Insert the morse taper drift (11) in the quill's slot, thus pushing the morse taper down and releasing the chuck, see fig 39-40.

**Fig 38-39-40**

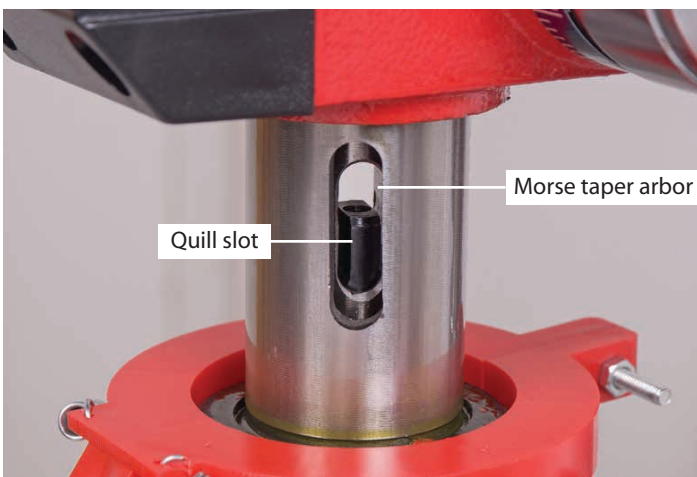



# MAINTENANCE



**WARNING! DISCONNECT THE MACHINE FROM THE MAINS SUPPLY BEFORE CONTINUING!**

## Cleaning

Excessive dust in the motor can cause heat to develop. Every effort should be made to prevent foreign material from entering the motor.

Where you may find accumulations of dust, dirt or waste, a visual inspection should be made at frequent intervals. Accumulations of dry dust can usually be blown out.

**Caution: To avoid eye injury or adverse reaction to dust, high pressure hoses should not be used especially in poorly ventilated areas.**

After cleaning apply a light coat of machine oil on the quill and chuck.

If the machine is going to stand idle for any length of time, a light coat of spray or machine oil over the column and table will prevent rusting. Place a dust sheet over the drill.

## Electric



**WARNING! DO NOT USE THE MACHINE IF THE POWER CABLE HAS BECOME DAMAGED**

If any servicing (other than the cleaning above) becomes necessary, the unit should be returned to Axminster Tool Centre for repair by one of our qualified electricians. Contact our customer sales department for further assistance on:

**Call: 03332 406406**

**(+441297 33666)**

**Email: [cs@axminstertools.com](mailto:cs@axminstertools.com)**



**WARNING! DO NOT ATTEMPT TO REPAIR IT YOURSELF CONTACT OUR TECHNICAL SALES TEAM FOR ASSISTANCE!**

## Motor speed

The speed of the motor cannot be regulated or changed - no adjustment is necessary.

Oil Points

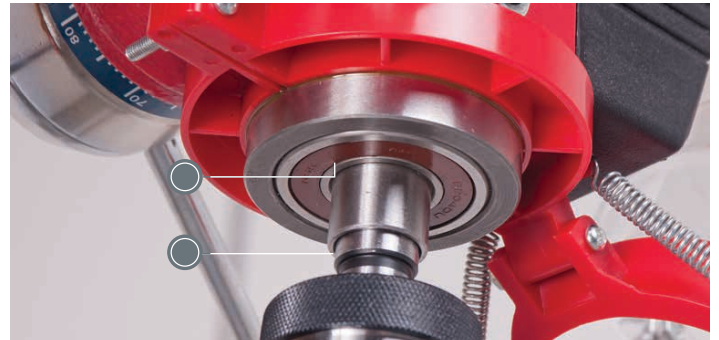
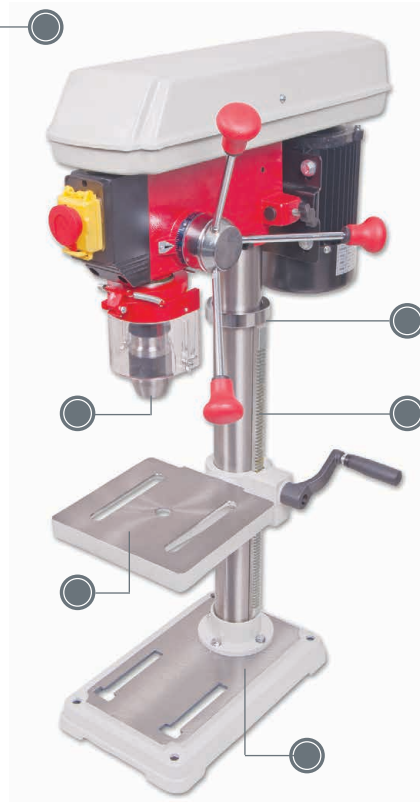

# SPEED SELECT TABLES

(5 Speed) **107690** AW285PD Bench Pillar Drill

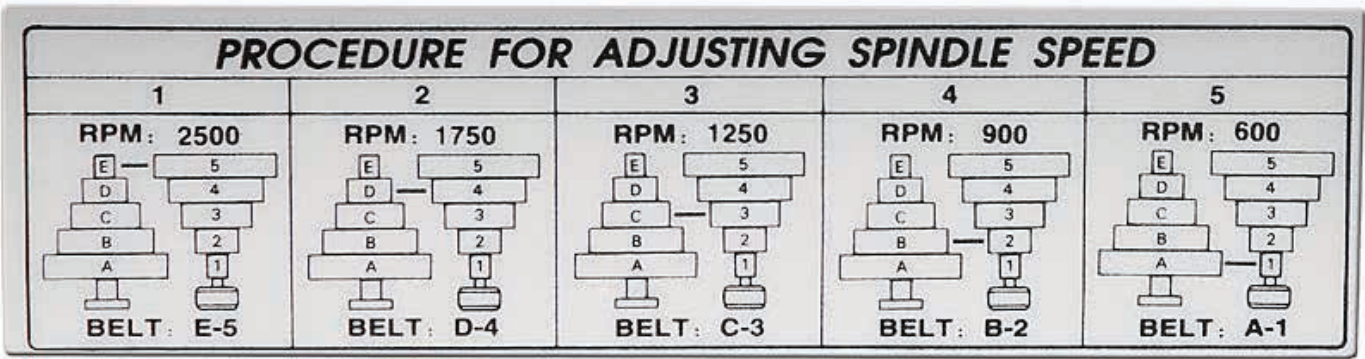

(12 Speed) **107691** AW315PD Bench Pillar Drill

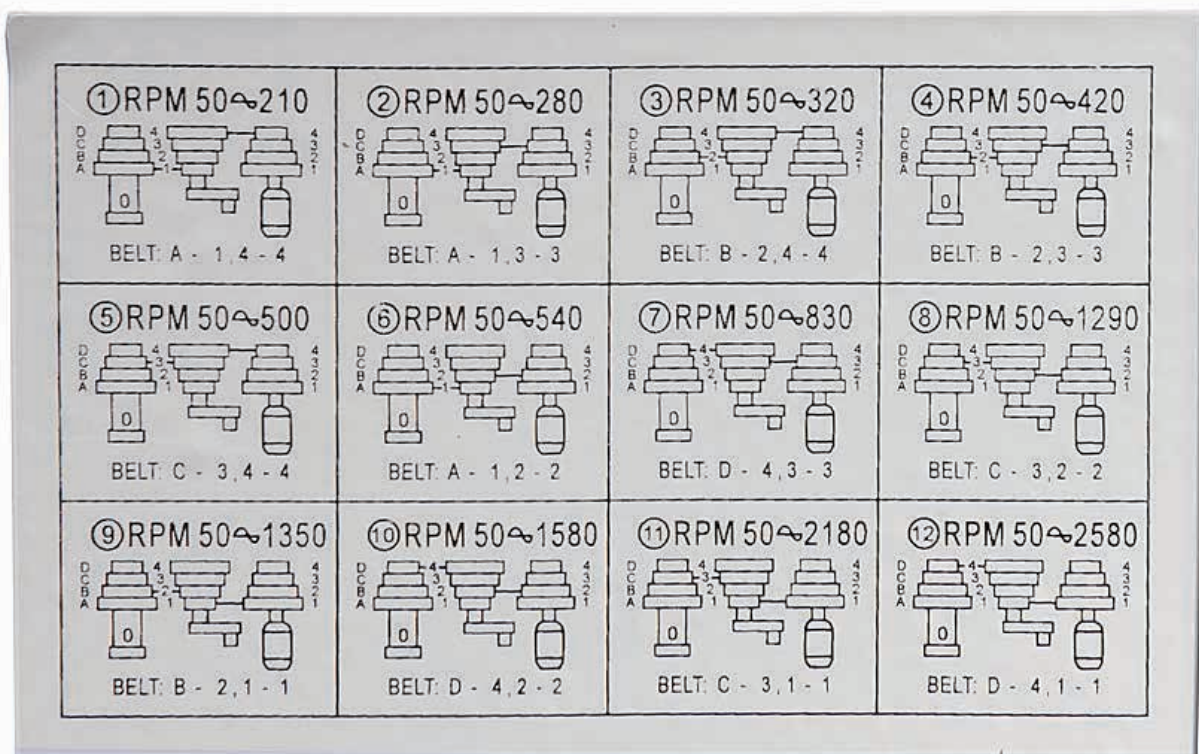

(5 Speed) **107692**AW220RD Bench Radial Pillar Drill **107693** AW680RD Floor Radial Pillar Drill

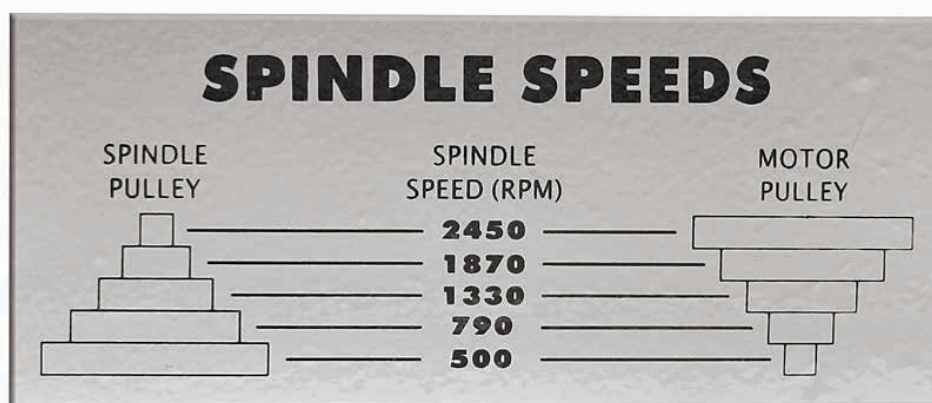

# DRILL SPEED MATERIAL TABLE

## 5 Speed

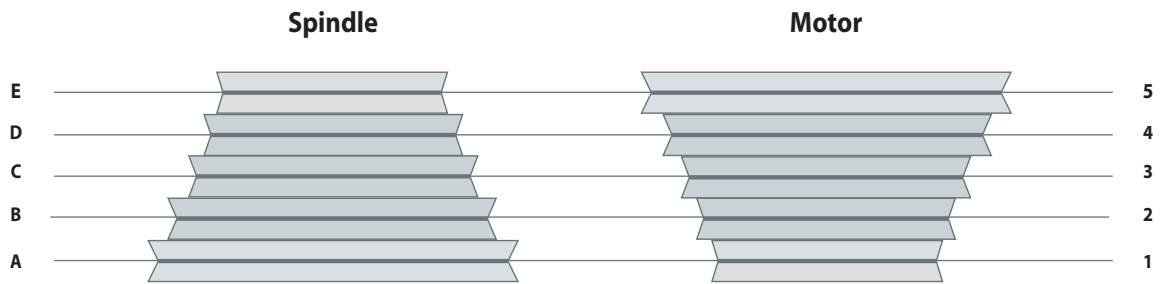

## 12 Speed

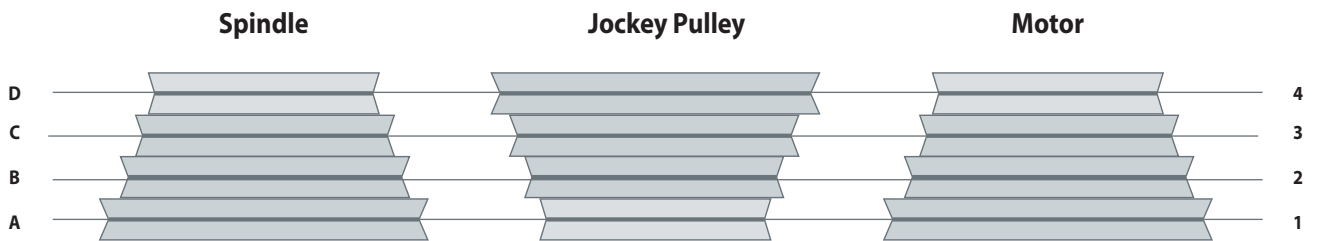

## Recommended Drill Size per Material

Average Guide Speed	Wood		Zinc Diecast		Aluminium or Brass		Plastic		Cast Iron and Bronze		Steel Mild and Malleable		Steel Cast and Carbon		Steel Stainless and Tool	
	inches	mm	inches	mm	inches	mm	inches	mm	inches	mm	inches	mm	inches	mm	inches	mm
50Hz																
2450-2500-2580 rpm	5/16"	7.9	3/16	4.8	11/64	4.4	5/32	4.0	7/16	2.8	3/32	2.4	1/16	1.6	1/32	0.8
1580-1750-1870 rpm	3/8	9.5	1/4	6.4	7/32	5.6	3/16	4.8	1/8	3.2	3/32	2.4	1/16	1.6	3/64	1.2
1250-1290-1330 rpm	5/8	15.9	3/8	9.5	11/32	8.7	5/16	7.9	1/4	6.4	5/32	4.0	1/8	3.2	1/16	1.6
790-830-900 rpm	7/8	22.2	1/2	12.7	15/32	11.9	7/16	11.1	11/32	8.7	1/4	6.4	3/16	4.8	1/8	3.2
500-540-600 rpm	1 1/4	31.8	3/4	19	11/16	17.5	5/8	15.9	1/2	12.7	3/8	9.5	5/16	7.9	1/4	6.4

TROUBLE	PROBABLE CAUSE	REMEDY
<b>Noisy Operation</b>	<ol style="list-style-type: none"> <li>1. Incorrect belt tension</li> <li>2. Dry spindle</li> <li>3. Loose spindle pulley</li> <li>4. Loose motor pulley</li> </ol>	<ol style="list-style-type: none"> <li>1. Adjust the tension</li> <li>2. Lubricate spindle</li> <li>3. Checking tightness of retaining nut on pulley, and tighten if necessary</li> <li>4. Tighten set screws in pulleys</li> </ol>
<b>Drill bit burns</b>	<ol style="list-style-type: none"> <li>1. Incorrect speed</li> <li>2. Chips not coming out of hole</li> <li>3. Dull drill bit</li> <li>4. Feeding too slow</li> <li>5. Not lubricated</li> </ol>	<ol style="list-style-type: none"> <li>1. Change speed</li> <li>2. Retract drill bit frequently to clear chips</li> <li>3. Resharpen drill bit</li> <li>4. Feed fast enough-allow drill bit to cut.</li> <li>5. Lubricate drill bit</li> </ol>
<b>Drill bit leads off hole not round</b>	<ol style="list-style-type: none"> <li>1. Hard grain in wood or lengths of cutting tips and/or angles not equal</li> <li>2. Bent drill bit</li> </ol>	<ol style="list-style-type: none"> <li>1. Resharpen drill bit correctly</li> <li>2. Replace drill bit</li> </ol>
<b>Wood splinters on underside</b>	<ol style="list-style-type: none"> <li>1. No "back-up material" under workpiece</li> </ol>	<ol style="list-style-type: none"> <li>1. Use "back-up material"</li> </ol>
<b>Workpiece torn loose from hand</b>	<ol style="list-style-type: none"> <li>1. Not supported or clamped properly</li> </ol>	<ol style="list-style-type: none"> <li>1. Support workpiece or clamp it</li> </ol>
<b>Drill bit binds in workpiece</b>	<ol style="list-style-type: none"> <li>1. Workpiece pinching drill bit or excessive feed pressure</li> <li>2. Improper belt tension</li> </ol>	<ol style="list-style-type: none"> <li>1. Support workpiece or clamp it</li> <li>2. Adjust tension</li> </ol>
<b>Excessive drill bit runout or wobble</b>	<ol style="list-style-type: none"> <li>1. Bent drill bit</li> <li>2. Worn spindle bearings</li> <li>3. Drill bit not properly installed in chuck</li> <li>4. Chuck not properly installed</li> </ol>	<ol style="list-style-type: none"> <li>1. Use a straight drill bit</li> <li>2. Replace bearings</li> <li>3. Install drill bit properly</li> <li>4. Install chuck properly</li> </ol>
<b>Quill returns too slow or too fast</b>	<ol style="list-style-type: none"> <li>1. Spring has improper tension</li> </ol>	<ol style="list-style-type: none"> <li>1. Adjust spring tension</li> </ol>
<b>Chuck will not stay attached to spindle it falls off when trying to install it</b>	<ol style="list-style-type: none"> <li>1. Dirty, grease or oil on the tapered inside surface of chuck or on the spindles tapered surface</li> </ol>	<ol style="list-style-type: none"> <li>1. Make sure all surfaces are free of dust and grease</li> </ol>



# EXPLODED DIAGRAMS/LISTS

AW285PD Bench Pillar Drill (ZQJ4113A)

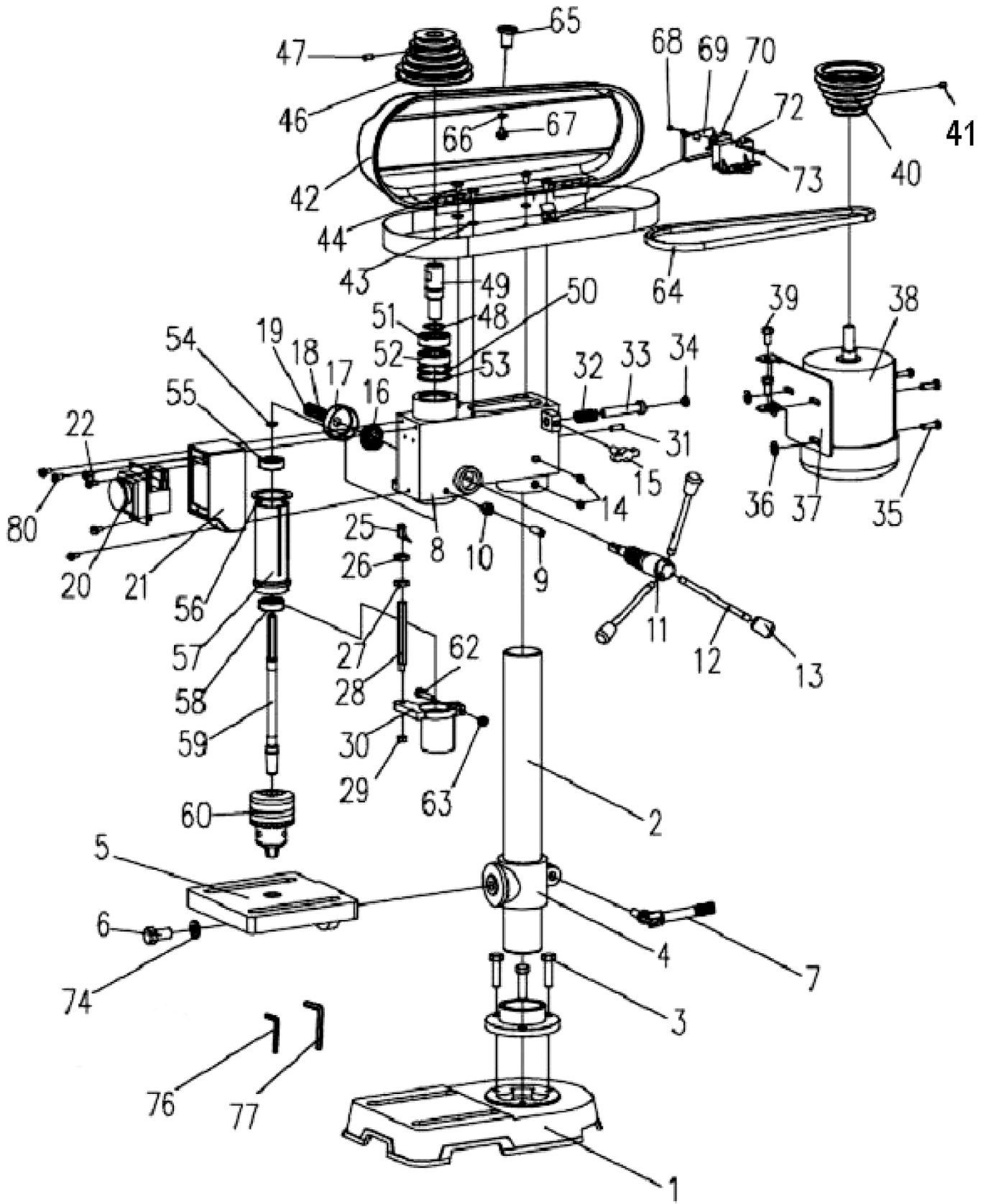



## AW285PD Bench Pillar Drill (ZQJ4113A)

NO	DESCRIPTION	QTY		DESCRIPTION	QTY
1	BASE	1	39	BOLT M8x16	2
2	COLUMN	1	40	MOTOR PULLEY	1
3	BOLT M8X20	3	41	HEADLESS SET SCREW	1
4	TABLE BRACKET	1	42	PULLEY COVER	1
5	SQUARE TABLE	1	43	WASHER	4
6	BOLT M12x25	1	44	SCREW M6X10	4
7	CLAMPING LEVER	1	46	SPINDLE PULLEY	1
8	BODY	1	47	HEADLESS SET SCREW	1
9	SCREW M6x18	1	48	RETAIN RING	1
10	NUT M6	1	49	INTERNAL SPLINE SLEEVE	1
11	FEED SHAFT	1	50	RETAIN RING	1
12	HANDLE BAR	3	51	BALL BEARING 6203-2RZ/Z1	1
13	KNOB	3	52	BALL BEARING 6203-2RZ/Z1	1
14	HEADLESS SET SCREW	2	53	RETAIN RING	1
15	SHIFTER BAR	1	54	RETAIN RING	1
16	SPRING SEAT	1	55	BALL BEARING 6201-2RZ-Z1	1
17	SPRING CAP	1	56	WASHER	1
18	NUT	1	57	SPINDLE SLEEVE	1
19	NUT	1	58	BALL BEARING 6201-2RZ-Z1	1
20	SWITCH	1	59	SPINDLE	1
21	SWITCH BOX	1	60	DRILL CHUCK	1
22	SCREW	3	62	BOLT M6X25	1
25	POINTER	1	63	NUT	1
26	NUT	1	64	V-BELT	1
27	NUT	1	65	HANDLE	1
28	LIMIT BOLT	1	66	WASHER	1
29	NUT	1	67	SCREW	1
30	CHUCK GUARD	1	68	NUT M3 OPTIONAL	2
31	PINS	1	69	PLATE OPTIONAL	1
32	SPRING	1	70	MICRO SWITCH OPTIONAL	1
33	ADJUSTING BAR	1	72	SUPPORT PLATE OPTIONAL	1
34	RUBBER PAD	1	73	SCREW M3X18 OPTIONAL	2
35	BOLT	3	74	SPRING WASHER	1
36	WASHER	3			1
37	MOTOR MOUNTING PLATE	1	76	HEX KEY 3 mm	1
38	MOTOR	1	77	HEX KEY 4 mm	1
			80	SCREW M4x10	4

# EXPLODED DIAGRAMS/LISTS

AW315PD Bench Pillar Drill (ZQJ4116Q)

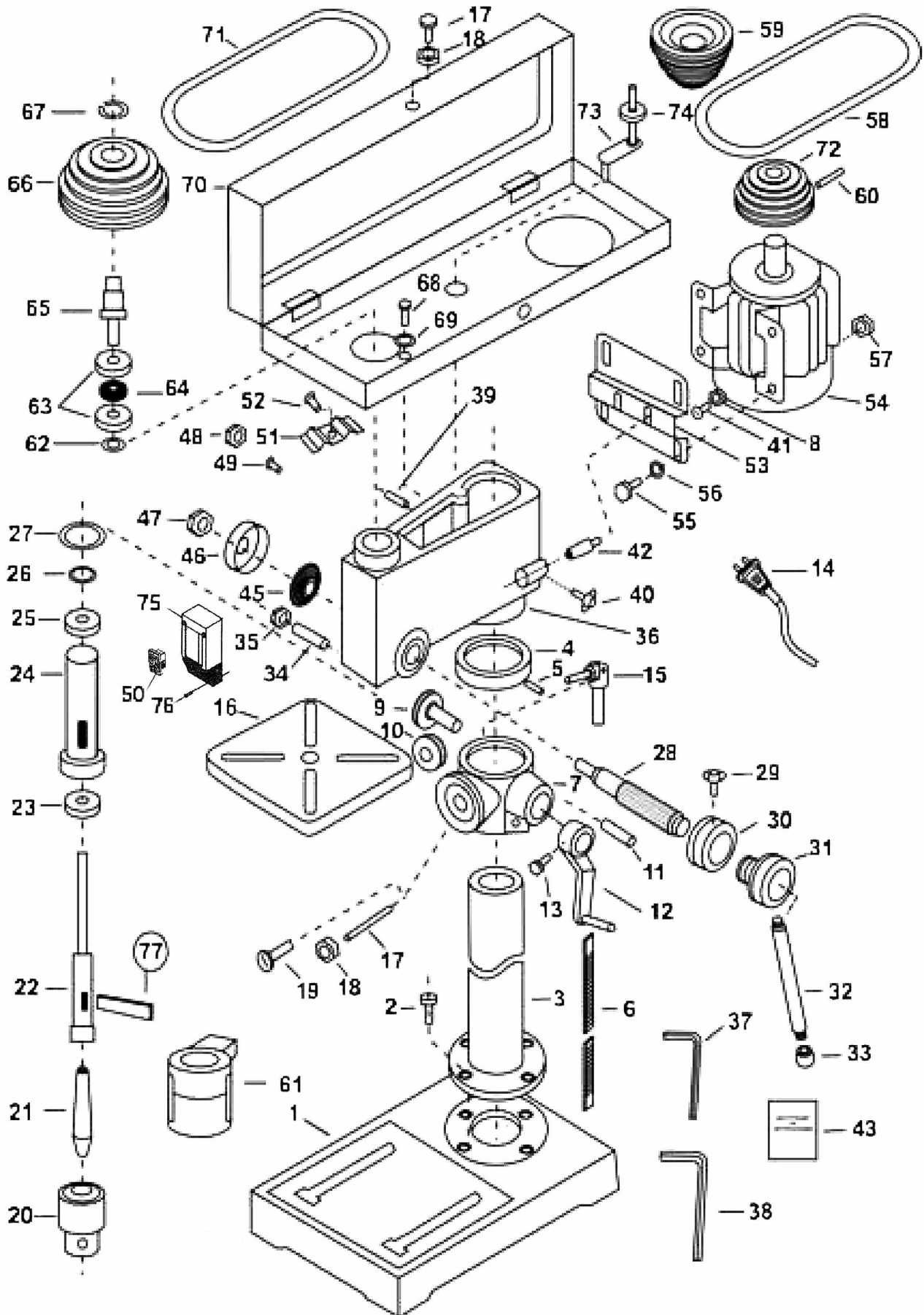

## AW315PD Bench Pillar Drill (ZQJ4116Q)

NO	DESCRIPTION	39	HEADLESS SET SCREW
1	BASE	40	SLIDE BAR BOLT
2	BOLT	41	SCREW
3	COLUMN	42	SLIDE BAR
4	RACK RING	43	INSTRUCTION MANUAL
5	HEADLESS SET SCREW	44	CHUCK KEY
6	RACK	45	SPRING
7	MOUNTING ARM BRACKET	46	SPRING SEAT
8	NUT	47	NUT
9	WORM GEAR	48	PLASTIC JAM NUT
10	GEAR	49	SCREW
11	SHAFT	50	SWITCH
12	HANDLE	51	WIRE CLAMP
13	SET BOLT	52	SCREW
14	PLUG	53	MOTOR MOUNTING PLATE
15	CLAMP BOLT	54	MOTOR
16	TABLE	55	BOLT
17	PIN	56	WASHER
18	NUT	57	NUT
19	SET SCREW	58	V-BELT
20	CHUCK	59	CENTRE PULLEY
21	ARBOR	60	HEADLESS SET SCREW
22	SPINDLE	61	CHUCK GUARD
23	BALL BEARING	62	RETAIN RING
24	SPINDLE SLEEVE	63	BALL BEARING
25	BALL BEARING	64	COLLAR
26	RETAIN RING	65	DRIVE SLEEVE
27	RUBBER WASHER	66	SPINDLE PULLEY
28	FEED SHAFT	67	PULLEY NUT
29	CLAMP BOLT	68	SCREW
30	SCALE RING	69	WASHER
31	HANDLE BODY	70	PULLEY COVER
32	HANDLE	71	V-BELT
33	KNOB	72	MOTOR PULLEY
34	HEADLESS SET SCREW	73	CENTER SHAFT
35	NUT	74	BALL BEARING
36	BODY	75	SWITCH BOX
37	HEX. KEY	76	SCREW M5 X 12
38	HEX. KEY	77	WEDGE

# EXPLODED DIAGRAMS/LISTS

AW220RD Bench Radial Drill (ZQJ3116)  
AW680RD Floor Radial Drill (ZQJ3116A)

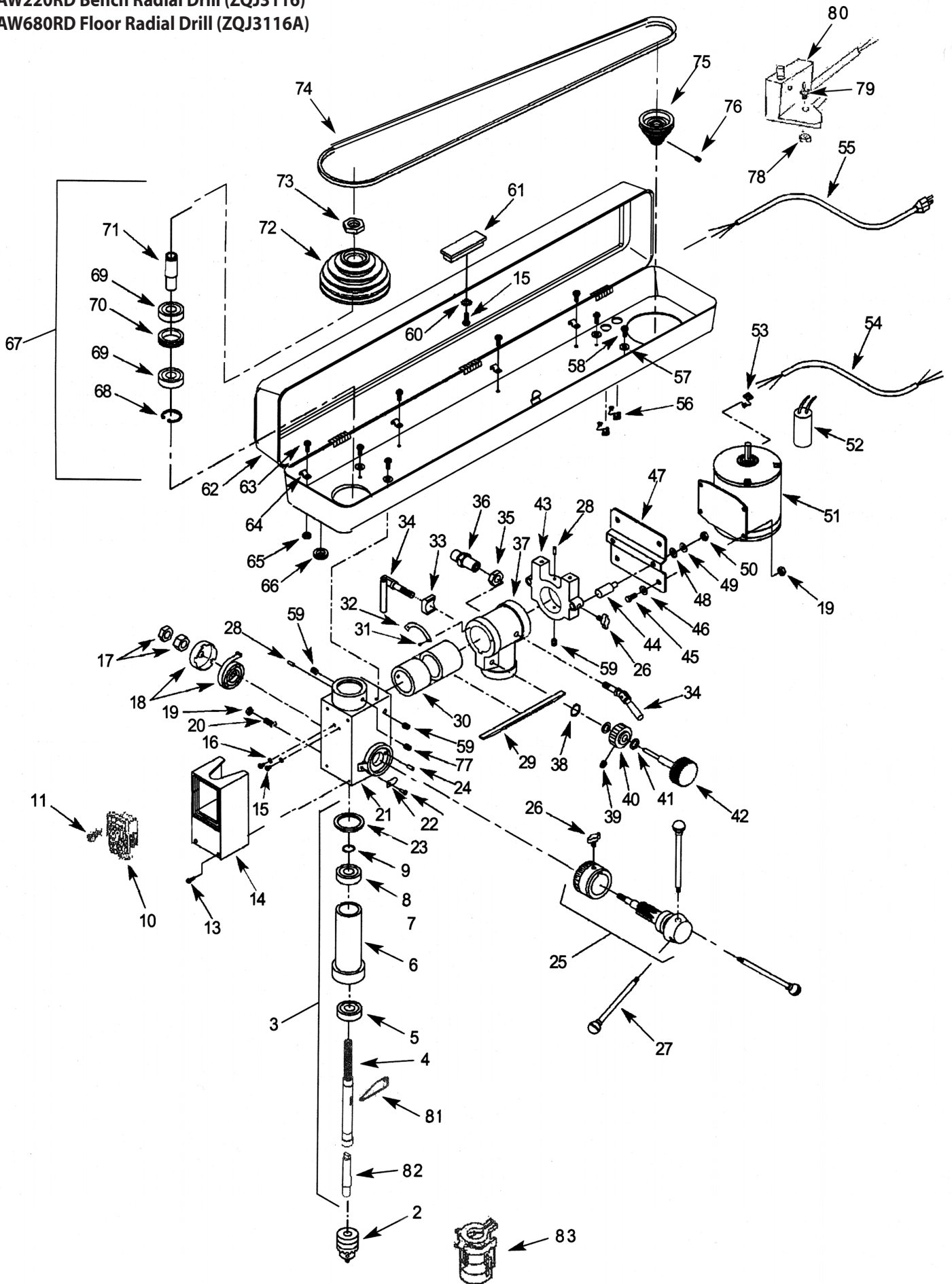



**AW220RD Bench Radial Drill (ZQJ3116)**  
**AW680RD Floor Radial Drill (ZQJ3116A)**

NO	DESCRIPTION	QTY
2	CHUCK	1
3	LOWER SPINDLE ASSEMBLY	1
4	SPINDLE	1
5	6202LL BALL BEARING	1
6	QUILL	1
7	6201LL BALL BEARING	1
8	RETAINING RING	1
9	RUBBER BUMPER	1
10	SWITCH	1
11	THREADFORMING SCREW	2
13	PAN HEAD SCREW	4
14	COVER	1
15	PAN HEAD SCREW	3
16	5MM SERRATED WASHER	2
17	HEX NUT	2
18	CAP COVER AND SPRING	1
19	HEX NUT	5
20	CONE POINT SET SCREW	1
21	DRILL PRESS HEAD	1
22	POINTER	1
23	RIVET	1
24	SPRING PIN	1
25	QUILL FEED ASSEMBLY	1
	(INCL. REF. NOS. 26 AND 27)	
26	KNOB	3
27	HANDLE WITH GRIP	3
28	SPRING PIN	2
29	RADIAL RACK	1
30	RAM	1
31	PAN HEAD SCREW	2
32	SCALE	1
33	LOCKING SHOE	1
34	HANDLE	2
35	HEX NUT	1
36	GUIDE PIN ASSEMBLY	1
37	RAM BRACKET (MODE:ZQJ3116)	1
37	RAM BRACKET (MODE:ZQJ3116A)	1
38	RETAINING RING	1
39	SET SCREW	1
40	GEAR	1
41	SPACER	2
42	KNOB	1

43	BRACKET	1
44	TENSION ADJUSTMENT BAR	2
45	HEX HEAD BOLT	4
46	8MM FLAT WASHER	4
47	MOTOR MOUNT PLATE	1
48	10MM FLAT WASHER	2
49	10MM LOCK WASHER	2
50	HEX NUT	2
51	MOTOR (INCL. REF. NOS. 52-54)	1
52	CAPACITOR	1
53	STRAIN RELIEF	1
54	MOTOR CORD	1
55	LINE CORD	1
56	STRAIN RELIEF	2
57	6MM FLAT WASHER	4
58	PAN HEAD SCREW	4
59	SET SCREW	3
60	5MM FLAT WASHER	1
61	KNOB	1
62	PULLEY HOUSING	1
63	PAN HEAD SCREW	4
64	CORD CLAMP	4
65	HEX NUT	4
66	GROMMET	1
67	UPPER SPINDLE ASSEMBLY	1
	(INCL. REF. NOS. 68-71)	
68	RETAINING RING	1
69	6203LL BALL BEARING	2
70	SPACER	1
71	UPPER SPINDLE SLEEVE	1
72	SPINDLE PULLEY	1
73	PULLEY NUT	1
74	V-BELT	1
75	MOTOR PULLEY	1
76	SET SCREW	1
77	CONE POINT SET SCREW	1
78	NUT	1
79	SCREW	1
80	SWITCH	1
81	WEDGE	1
82	LIVE AXLE	1
83	GUARD	1

# EXPLODED DIAGRAMS/LISTS

## AW220RD Bench Radial Drill (ZQJ3116)

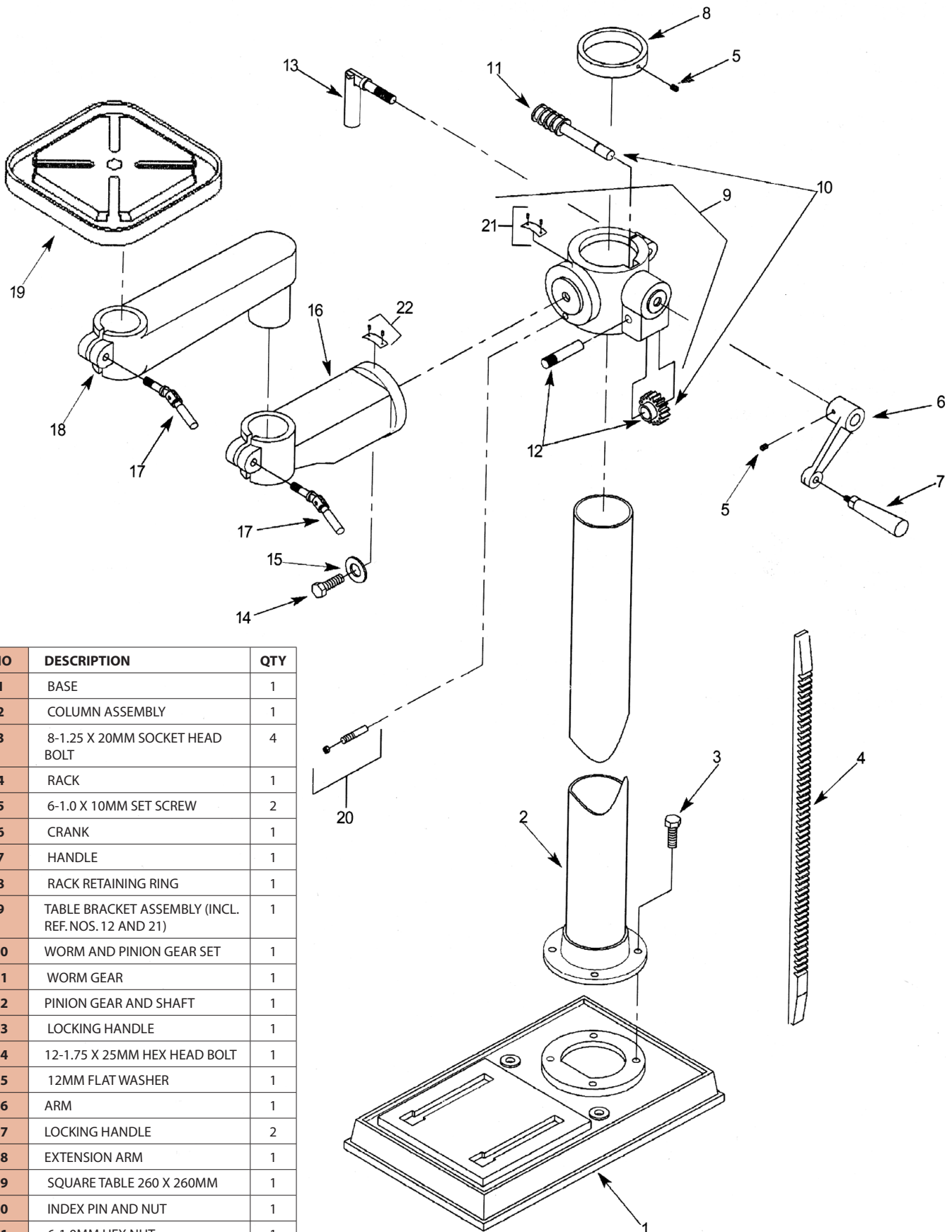

NO	DESCRIPTION	QTY
1	BASE	1
2	COLUMN ASSEMBLY	1
3	8-1.25 X 20MM SOCKET HEAD BOLT	4
4	RACK	1
5	6-1.0 X 10MM SET SCREW	2
6	CRANK	1
7	HANDLE	1
8	RACK RETAINING RING	1
9	TABLE BRACKET ASSEMBLY (INCL. REF. NOS. 12 AND 21)	1
10	WORM AND PINION GEAR SET	1
11	WORM GEAR	1
12	PINION GEAR AND SHAFT	1
13	LOCKING HANDLE	1
14	12-1.75 X 25MM HEX HEAD BOLT	1
15	12MM FLAT WASHER	1
16	ARM	1
17	LOCKING HANDLE	2
18	EXTENSION ARM	1
19	SQUARE TABLE 260 X 260MM	1
20	INDEX PIN AND NUT	1
21	6-1.0MM HEX NUT	1
22	SCALE WITH RIVETS	1
22	INDICATOR WITH RIVETS	1

## AW680RD Floor Radial Drill (ZQJ3116A)

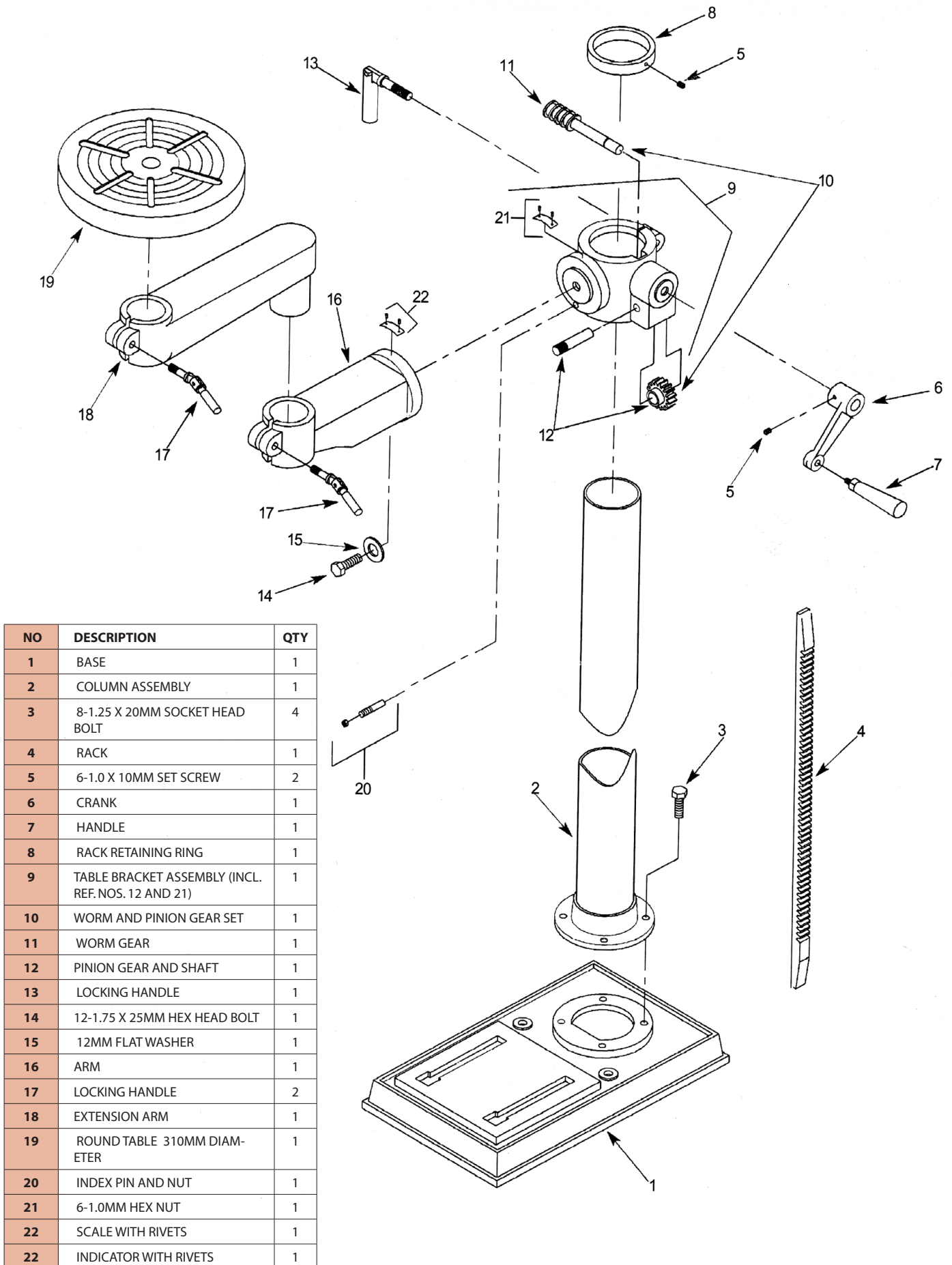



# WIRING DIAGRAM

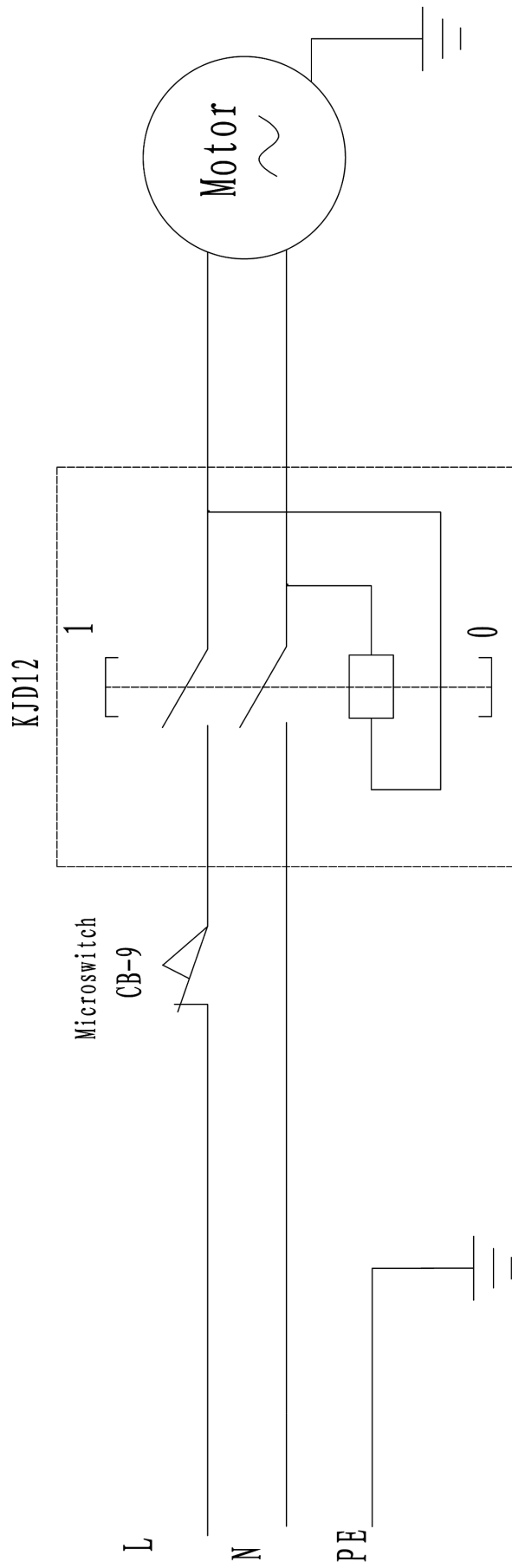



# NOTES

---





## The Axminster guarantee

Buy with confidence from Axminster!

So sure are we of the quality, we cover all parts and labour free of charge for three years!



For more information visit [axminstertools.com/3years](https://axminstertools.com/3years)



The packaging is suitable for recycling.  
Please dispose of it in a responsible manner.



### EU Countries Only

Do not dispose of electric tools together with household waste material.  
By law they must be collected and recycled separately.



Axminster Tools, Axminster Devon EX13 5PH

[axminstertools.com](https://axminstertools.com)